

**YCF**  
ENJOY YOUR RIDE





**YANNICK COQUARD  
CO-FOUNDER & FORMER  
PROFESSIONAL RACER**

**NORMANDIE, FRANCE**

**DEPUIS 2004, YCF® DÉVELOPPE ET FABRIQUE DES MOTOS POUR LE GRAND PUBLIC, LE LOISIR ET LA COMPÉTITION. CHAQUE ANNÉE UNE NOUVELLE GAMME COMPLÈTE DE MOTOS FIABLES, ACCESSIBLES ET PERFORMANTES EST PROPOSÉE AFIN DE PROFITER PLEINEMENT DES JOIES DE LA MINI MOTO EN TOUTE SÉCURITÉ.**

**100% DES PRODUITS YCF SONT CONÇUS, DÉVELOPPÉS ET DESSINÉS EN INTERNE. GRACE AU DÉVELOPPEMENT EN COMPÉTITION, LES PRODUITS YCF BÉNÉFICIENT DES DERNIÈRES ÉVOLUTIONS DISPONIBLES POUR LE GRAND PUBLIC, POUR TOUTE LA FAMILLE.**

**BON RIDE À TOUS**

**YCF® HAS BEEN DEVELOPING AND MANUFACTURING MOTORCYCLES FOR THE PAST 16 YEARS. OUR BIKES ARE MATCHED TO SKILL LEVELS FROM BEGINNERS TO ADVANCED. WHETHER YOU'RE PLAY RIDING OR COMPETING, THERE'S A BIKE FOR YOU! EACH YEAR A NEW RANGE OF RELIABLE, AFFORDABLE AND HIGH-PERFORMANCE MOTORCYCLES ARE INTRODUCED. ALLOWING YOU TO EXPERIENCE ALL THE FUN MINI BIKES HAVE TO OFFER. 100% OF YCF PRODUCTS ARE DEVISED, DESIGNED AND DEVELOPED IN-HOUSE. DUE TO BEING DEVELOPED UNDER COMPETITION CONDITIONS, YCF® TAKE'S ADVANTAGE OF THE VERY LATEST ADVANCES. THANK YOU FOR CHOOSING YCF®.**

**ENJOY YOUR RIDE!**



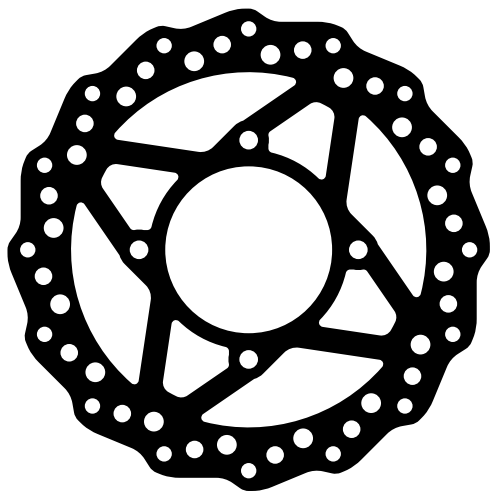

SPECIAL PARTS



FACTORY PARTS



FOR 50 ONLY



FOR SUPERMOTO



FOR BIGY® ONLY



ARRO® TIRES



DAYTONA® ENGINES



ENGI® FORK



MIKUNI® CARBURETORS



KEIHIN® CARBURETORS



TWINAIR® FILTERS



NIBBI CARBURETORS®



KENDA® TIRES



DNM® SUSPENSIONS



## GAMME 2023 RANGE 2023

YCF 50A	10
YCF 50E	12
LITE F88S	16
LITE F125	18
LITE F110RSE	20
LITE F110R	22
START F88SE	24
YCF W88	26
START F125	28
START F125SE	30
PILOT F125	32
PILOT F150E	34
FACTORY SP2 F150	36
FACTORY SP3 F190	38
BIGY 125 MX	40
BIGY 150 MX	42
BIGY 150 MX-E FACTORY	44
BIGY 190 MX FACTORY DAYTONA®	46
SM F125	48
SM F155	50
SM F190	52
BIGY SM F190 DAYTONA®	54
PADDOCK/ PADDOCK	56
TEXTILES/ APPAREL	58

## ACCESSOIRES PLASTIQUES PLASTIC PARTS

KITS DÉCO/ GRAPHIC KITS	60
PERSONNALISATION/ CUSTOMIZATION	65
KITS PLASTIQUES/ PLASTIC KITS	66

## PIÈCES MOTO CYCLE PARTS

GUIDONS/ HANDLEBARS	74
POIGNÉES/ LEVERS	76
FOURCHES/ FORKS	78
CADRES/ FRAMES	81
SELLES/ SEATS	82
RÉSERVOIRS/ FUEL TANKS	83
FREINS/ BRAKES	84
BRAS OSCILLANTS/ SWING ARMS	92
AMORTISSEURS/ SHOCK ABSORBERS	94
ROUES/ WHEELS	95
JANTES & MOYEUX/ RIMS & HUBS	95
PNEUS/ TIRES	102
REPOSE-PIEDS & SABOTS/ FOOT PEGS & SKID PLATES	104
SÉLECTEURS/ SHIFT LEVERS	105
KITS CHAÎNES/ SPROCKET KITS	106
OUTILS/ TOOLS	108
ENGI®/ ENGI®	110
PIÈCES SPÉCIALES SUPERMOTARD/ SUPERMOTO FACTORY SPECIAL PARTS	112

## PIÈCES MOTEUR ENGINE PARTS

MOTEURS DAYTONA®/ DAYTONA® ENGINES	118
MOTEURS/ ENGINES	119
KITS MOTEUR/ ENGINE KITS	120
EMBRAYAGE/ CLUTCH	123
CARBURATEURS/ CARBURETORS	125
FILTRES À AIR/ AIR FILTERS	127
ÉCHAPPEMENTS/ EXHAUSTS	128
FILTRES & RADIATEURS/ FILTERS & COOLERS	131
ALLUMAGE/ IGNITION	132
PIÈCES RACING DAYTONA®/ DAYTONA® RACING PARTS	134
PIÈCES D'ORIGINE DAYTONA®/ DAYTONA® PARTS	135

# INDEX - FRENCH 2023

## A

AIGUILLE DE CARBURATEUR.....	125
ALLUMAGE.....	132/134
AMORTISSEUR.....	94/111
ANTIPARASITE.....	133
ARBRE DE BOÎTE.....	122
ARRACHE VOLANT.....	108
ATTACHE RAPIDE DE CHAÎNE.....	106
ATTACHE SILENCIEUX.....	128/129
AXE DE BRAS OSCILLANT.....	93
AXE DE ROUE.....	99
AXE DE PLAQUETTE DE FREIN.....	84

## B

BÂCHE MOTO.....	56
BAGUE DE FOURCHE.....	78/110
BANDEROLE.....	56
BANNER.....	56
BARNUM.....	56
BARRE DE REPOSE-PIED.....	104
BATTERIE.....	132
BAVETTE D'AMORTISSEUR.....	94
BÉQUILLE.....	57/81
BOBINE D'ALLUMAGE.....	132
BOÎTE À AIR.....	127
BONNET.....	58
BOUCHON DE CARTER D'ALLUMAGE.....	120
BOUCHON DE RÉSERVOIR.....	83
BOUCHON DE VALVE.....	102
BOUCHON DE VIDANGE.....	131
BOUCLE ARRIÈRE.....	81
BOUGIE.....	133
BRAS OSCILLANT.....	92
BRIDE DE POT.....	128

## C

CÂBLE DE GAZ.....	77
CÂBLE D'EMBRAYAGE.....	77
CÂBLE DE PÉDALE DE FREIN.....	88
CACHE CULASSE.....	134
CACHE FILTRE À HUILE.....	134
CACHE POUSSIÈRE.....	110
CADRE.....	81
CAGE DE FILTRE À AIR.....	127

CALE PLASTIQUE DE PIPE D'ADMISSION.....	126
CALE DE PONTET DE GUIDON 20 mm.....	79
CAOUTCHOUC D'EMBRAYAGE.....	77
CAOUTCHOUC DE LEVIER DE FREIN.....	77
CAOUTCHOUC D'ÉTRIER.....	87
CAPOT DE MAÎTRE-CYLINDRE FREIN.....	91
CARBURATEUR.....	125
CARTER D'ALLUMAGE.....	120/121
CARTER D'EMBRAYAGE.....	123
CASQUETTE.....	58
CDI.....	132
CERCEAU DE ROUE.....	98/99
CHAÎNE.....	106
CHAÎNE DE DÉMARREUR.....	120/134
CHAÎNE DE DISTRIBUTION.....	120/134
CHAISE PLIABLE.....	56
CHAMBRE À AIR.....	102
CHAPE DE MAÎTRE-CYLINDRE.....	88
CHAPEAU.....	59
CHARGEUR BATTERIE.....	132
CLÉ À BOUGIE.....	108
CLÉ À RAYON.....	108
CLOCHE D'EMBRAYAGE.....	124
COCOTTE D'EMBRAYAGE.....	77
COLLECTEUR.....	130
COMPTEUR D'HEURES.....	133
CONTACTEUR À CLÉ.....	132
CONTROLEUR DIGITAL.....	108
COUPE CIRCUIT.....	133
COURONNE.....	106/107
COURONNE D'EMBRAYAGE.....	123
COUVERCLE DE FILTRE À AIR.....	127
COUVRES RAYONS.....	99
COUVRE RÉSERVOIR.....	83
CULASSE.....	122
CYLINDRE.....	122

## D

DAYTONA® (PIÈCES).....	134-139
DÉRIVE CHAÎNE.....	108
DÉMONTE PNEU.....	108
DÉMONTE NOIX EMBRAYAGE.....	108
DÉCO DE CADRE.....	60
DIABOLO CNC.....	92
DISQUE DE FREIN.....	90
DISQUE D'EMBRAYAGE.....	123
DONUTS.....	77
DURITE D'ESSENCE.....	83
DURITE DE FREIN.....	86/87
DURITE D'HUILE RADIATEUR.....	130

## E

ÉCHAPPEMENT.....	129-130
ÉCHAPPEMENT COMPLET.....	129
ÉCROU DE BÉQUILLE.....	81
ÉCROU DE COLONNE DE DIRECTION.....	80
EMBOUT DE PÉDALE DE FREIN.....	88
EMBOUT DE POT.....	128/129
EMBOUT DE MAÎTRE-CYLINDRE FREIN.....	88
EMBOUT PLASTIQUE DE GUIDON.....	77
EMBRAYAGE COMPLET.....	123
ENGI® (PIÈCES).....	110/111
ENTRETOISE D'AMORTISSEUR.....	94
ENTRETOISE DE ROUE.....	100
ÉPURATEUR D'HUILE.....	130
ÉTRIER DE FREIN.....	84/86-87

## F

FAISCEAUX ÉLECTRIQUES.....	132
FEUTRINE.....	56
FILTRE À AIR.....	127
FILTRE À HUILE.....	130
FOND DE JANTE.....	102
FOURCHE.....	78/110
FOURCHETTE DE BOÎTE.....	122
FREIN ARRIÈRE.....	84-87
FREIN AVANT.....	84-86
FREIN FILET.....	108

## G

GARDE BOUE ARRIÈRE.....	68/69
GARDE BOUE AVANT.....	66/69/71
GICLEUR.....	125
GRIPSTER.....	99
GUIDE DE CHAÎNE.....	93
GUIDON.....	75

## H

HUBLOT À HUILE.....	131
---------------------	-----

## J

JANTES.....	98-99
JAUGE À HUILE.....	131
JEU DE CALES MOTEUR.....	108
JEU DE RAYONS.....	99
JOINT DE BOUCHON DE RÉSERVOIR.....	83
JOINT DE CARTER D'EMBRAYAGE.....	124
JOINT DE COLONNE DE DIRECTION.....	80
JOINT DE CUVE POUR CARBURATEUR.....	125
JOINT PAPIER DE PIPE D'ADMISSION.....	126

JOINT DE POT .....	128
JOINT DE QUEUE DE SOUPAPE.....	122
JOINT SPY DE FOURCHE .....	78/110
JOINT SPY DE TIGE COMMANDE D'EMBRAYAGE .....	124
JOINT SPY DE KICK .....	124
JOINT SPY DE PSB .....	124
JOINT SPY DE ROUE.....	99
JOINT SPY DE SÉLECTEUR .....	124

## K

KICK .....	105
KIT 212cc .....	134
KIT ARBRE À CAMES RACING .....	124/134
KIT DÉCO .....	60-64
KIT DÉCO DE CADRE .....	60
KIT DÉPART .....	110
KIT FREIN .....	84/85/86
KIT LAMPE .....	72
KIT PISTON .....	121/134
KIT PLASTIQUE .....	66-71
KIT RABASSE.....	94
KIT RÉFECTION D'AMORTISSEUR .....	111
KIT RÉFECTION ENTRETOISE AXE AMORTISSEUR ...	111
KIT RÉFECTION DE FOURCHE.....	78
KIT RONDELLE CNC .....	72
KIT ROUE SUPERMOTARD .....	95
KIT ROULEMENT DE COLONNE DE DIRECTION .....	80
KIT STABILISATEUR .....	14
KIT SUPERMOTARD .....	105/112
KIT VIS.....	72/90/107/125

## L

LAINA DE ROCHE.....	128
LEVIER D'EMBRAYAGE.....	76/77
LEVIER DE FREIN .....	76/77/84

## M

MAÎTRE-CYLINDRE .....	84-86
MANCHON DE BOÎTE À AIR .....	127
MANCHON DE PIPE D'ADMISSION .....	126
MOTEUR .....	118-119
MOUSSE DE GUIDON .....	74
MOYEU .....	100

## N

NUMÉROS .....	65
---------------	----

## O

ORIFLAMME .....	56
OUÏE DE RADIATEUR .....	66/69

OUTILLAGE.....	108/110
----------------	---------

## P

PARAPLUIE .....	58
PASSE DURITE DE FREIN AVANT.....	72
PATTE DE CADRE .....	80
PATTE DE FREIN CNC.....	84
PATIN DE BRAS OSCILLANT .....	93
PATIN DE CHAÎNE .....	93
PÉDALE DE FREIN .....	88
PIÈCES D'ORIGINE DAYTONA®.....	135-139
PIGNON .....	122/124
PIGNON DE CLOCHE D'EMBRAYAGE .....	122
PIGNON DE SORTIE DE BOÎTE .....	106
PIPE D'ADMISSION .....	126/134
PISTON .....	121/134
PLANCHE DE STICKERS.....	65
PLAQUE AVANT.....	66/70
PLAQUES LATÉRALES.....	61/64
PLAQUE PHARE .....	72
PLAQUETTES DE FREIN .....	90
PLATEAU D'ALLUMAGE .....	132
PLATINE RÉGLABLE AVEC REPOSE PIED.....	104
PNEU.....	102-103
POCHETTE DE JOINTS .....	122
POIGNÉE DE GAZ .....	76
POIGNÉES CAOUTCHOUC.....	77
POIGNÉES DE PLAQUES LATÉRALE.....	67/70
POINTEAU DE CARBURATEUR.....	125
POLO .....	58
PONTET DE GUIDON .....	79
PROTECTION DE FOURCHE.....	68
PROTECTION DE PIGNON SORTIE BOÎTE.....	107
PROTECTION SM .....	104
PROTÈGE DISQUE ARRIÈRE .....	93
PROTÈGE DISQUE AVANT .....	72
PROTÈGE LEVIER .....	74
PROTÈGE MAIN .....	74
PROTÈGE MAÎTRE-CYLINDRE.....	88

## R

RAYONS.....	99
RADIATEUR D'HUILE .....	131
RÉGULATEUR DE TENSION .....	132
RELAIS DE DÉMARREUR .....	132
REPOSE PIED.....	104
RÉSERVOIR.....	83
RÉSERVOIR RÉCUPÉRATEUR HUILE/ ESSENCE .....	104
RESSORT D'AMORTISSEUR .....	94
RESSORT DE BÉQUILLE .....	81

RESSORT DE KICK.....	105
RESSORT DE PÉDALE DE FREIN.....	88
RESSORT DE POT .....	128/129
RESSORT POUR ÉTRIER RADIAL.....	84
ROBINET D'ESSENCE .....	83
ROUES.....	14/95-98
ROULEMENT DE COLONNE DE DIRECTION.....	80
ROULEMENT DE ROUE.....	99
ROULEMENT DE BRAS OSCILLANT .....	93
ROULETTE DE CHAÎNE.....	93
RUBALISE DE TERRAIN .....	56

## S

SABOT.....	104
SAC À DOS/TRANSPORT .....	59
SEGMENT .....	121
SÉLECTEUR .....	105
SELLE.....	82
SILENCIEUX .....	129
SOUPAPE.....	122
STARTER AU GUIDON .....	126
SUPPORT DE COMPTEUR D'HEURES .....	133
SURFILTRE À AIR .....	127
SWEAT .....	58

## T

TAPIS .....	57
TÉ DE FOURCHE .....	78/79
TEESHIRT.....	58
TENDEUR DE CHAÎNE .....	107
TIGE DE COMMANDE D'EMBRAYAGE .....	124
TONNELLE .....	56
TRÉPIED.....	57

## V

VALVE COUDÉE 90°.....	95
VALVE PRISE AIR .....	83
VILEBREQUIN.....	121
VIS DE BÉQUILLE.....	81
VIS DE COURONNE .....	107
VIS DE CUVE.....	125
VIS DE DISQUE .....	90
VIS DE RALENTI.....	125
VIS ET ÉCROU TENDEUR DE CHAÎNE .....	93
VIS DE PLAQUETTE DE FREIN .....	90
VIS DE RÉGLAGE DE LA POIGNÉE DE GAZ .....	76
VIS RENFORCÉES POUR MOTEUR .....	81
VIS DE RICHESSE .....	125
VISSERIE .....	72/81/107

# INDEX - ENGLISH 2023

## A

AIR FILTERS.....	127
AIRBOX CAPS.....	127
AIRBOX RUBBER SLEEVES.....	127
AIRBOXES.....	127
APPAREL.....	58
AXLES.....	99

## B

BACKPACK.....	56
BANNER ROLL.....	56
BANNERS.....	56
BAR END CAPS.....	77
BAR MOUNTS.....	79
BATTERY CHARGER.....	132
BEANIE.....	58
BEARINGS.....	93/99
BIKE STANDS.....	57
BOLT KIT FOR AXLE BLOCK.....	93
BOLT KIT FOR BRAKE DISC.....	90
BOLT KITS FOR FUEL TANK.....	72
BOLT KIT FOR PLASTIC KIT.....	72
BOLT KIT FOR SEAT.....	72
BOLT KIT FOR SPROCKET.....	107
BRAKE CALIPERS.....	84-87
BRAKE CLEVIS.....	88
BRAKE DISCS.....	90
BRAKE GUARDS (FRONT).....	72
BRAKE HOSES.....	72
BRAKE LEVERS.....	76/77/84
BRAKE LEVER RUBBERS.....	77
BRAKE MASTER CYLINDERS.....	84/86
BRAKE PADS.....	90
BRAKE PEDALS.....	88
BRAKE RESERVOIR COVER.....	91
BRAKE SYSTEMS (COMPLETE).....	84-87

## C

CAMSHAFT KIT.....	124/134
CAP BIG VIEW HOLE.....	120
CAPS.....	58
CARBURETOR FLOAT.....	125
CARBURETORS.....	125
CDI.....	132

CHAIN GUIDES.....	93
CHAIN LINKS.....	108
CHAIN SLIDERS.....	93
CHAIN TENSIONERS.....	93
CHAIN TOOLS.....	108
CHAINS.....	106
CHOKE LEVER.....	126
CLUTCH ASSEMBLY.....	123
CLUTCH BRACKET.....	77
CLUTCH CABLES.....	77
CLUTCH CONTROL OIL SEAL.....	124
CLUTCH COVER.....	123
CLUTCH FOR KICKSTARTER.....	123/124
CLUTCH LEVER RUBBERS.....	77
CLUTCH LEVERS.....	76-77
CLUTCH SPROCKET.....	122/123
CLUTCH TOOLS.....	108
COUNTERSHAFT SPROCKET.....	106
COUNTERSHAFT SPROCKET GUARD.....	107
CRANKSHAFTS.....	121
CUSTOM NUMBERS.....	65
CYLINDERS.....	122

## D

DAYTONA ENGINE 212 KIT.....	134
DAYTONA® PARTS.....	134-139
DIGITAL TIRE PRESSURE GAUGE.....	108
DISCS.....	90
DISK GUARD.....	72/93
DUST SEALS.....	99

## E

ENGI®.....	110/111
ENGINE ADJUSTMENT GAUGES.....	108
ENGINE BASH PLATE STEEL.....	104
ENGINE KITS.....	120/134
ENGINE REINFORCED BOLT SETS.....	81
ENGINES (COMPLETE).....	118/119
EXHAUSTS.....	128/129/130
EXHAUST END.....	128/129
EXHAUST PIPE.....	128/129
EXHAUST SEWER.....	130
EXHAUST SPRING.....	128/129
EXHAUST VALVE.....	122

## F

FENDER.....	66/68/69/71
FILTER.....	127
FLAGS (PROMOTIONAL).....	56
FLYWHEEL REMOVER.....	108

FOAM AIR FILTER.....	127
FOLDABLE LEVERS.....	76
FOLDING CHAIR.....	56
FOOT PEG MOUNT BAR.....	104
FOOT PEGS.....	104
FORK AIR BLEEDER.....	78
FORK BUSHINGS ENGI®.....	110
FORK GUARDS.....	68
FORK OIL SEALS.....	78/110
FORK SEAL REPAIR KIT.....	78/110
FORKS.....	78/110
FORK TOOL.....	110
FRAMES.....	81
FUEL CAPS.....	83
FUEL HOSES.....	83
FUEL TANKS.....	83
FUEL TAPS.....	83
FUEL VENT PIPES.....	83

## G

GASKET SETS.....	122/124/125
GEARBOX FORK (REINFORCED).....	122
GEARBOX SHAFT.....	122
GEARBOX SHAFT (COMPLETE MAIN).....	122
GEARBOX SHAFT (COMPLETE SECONDARY).....	122
GRAPHIC KITS.....	60-64
GRAPHICS FOR FRAME.....	60
GRIPS.....	77
GRIP DONUTS.....	77

## H

HANDGUARDS.....	74
HANDLEBAR PADS.....	74
HANDLEBARS.....	75
HATS.....	58/59
HEAD LIGHTS.....	72
HEIGHT ADJUSTMENT KIT.....	94
HIGH TENSION IGNITION COIL.....	132
HOLESHOT DEVICE.....	110
HOODIE.....	58
HOOR METER.....	133
HUB SPACERS.....	100
HUBS.....	100

## I

IDLE SCREW + SPRING.....	125
IGNITION COVER.....	120
IGNITION SWITCH.....	132
INLET PIPE.....	126
INLET VALVE.....	122



INTAKE GASKET.....	126
INTAKE MANIFOLD .....	126

## K

KICKSTAND (ADJUSTABLE).....	81
KICKSTAND SPRING .....	81
KICKSTARTER LEVER OIL SEAL .....	124
KICKSTARTER LEVERS .....	105
KICKSTARTER SPROCKET .....	124
KILL SWITCH.....	132

## L

LIGHT.....	72
LIGHTED OIL PURIFIER .....	131
LEVER PROTECTION .....	74
LAUNCH CONTROL.....	108

## M

MAGNETIC DRAIN PLUG .....	131
MAGNETO .....	132
MAIN JET .....	125
MOTORCYCLE COVER .....	56
MUD FLAP .....	94
MUDGUARDS.....	14/66/68/69/71
MUFFLER .....	128/129
MUFFLER CLAMPS .....	128/129
MUFFLER SPARK ARRESTOR.....	128

## N

NEEDLE VALVE + SPRING .....	125
NIPPLE WRENCH .....	108
NUMBER PLATES.....	66/67/70
NUMBERS (CUSTOM).....	65
NUT FOR STEERING STEM.....	80

## O

OIL COOLER .....	131
OIL DIPSTICK .....	131
OIL DRAIN PLUG .....	131
OIL FILTER .....	131
OIL LEVEL SIGHT GLASS.....	131
OIL SEAL .....	99
OIL SEAL ASSEMBLY TOOLS.....	108
OIL SEAL FOR COUNTERSHAFT SPROCKET .....	124
OIL STEEL LINE RETAINER .....	72
OVAL MUFFLER CLAMP .....	128

## P

PISTON KITS .....	120/134
PISTON RING SETS.....	120

PIT TENT (3X3M) .....	56
PLASTIC KITS.....	66-71
POLO .....	58
PUSH ROD.....	124

## R

REAR BRAKE LEVER TIPS.....	88
REAR SPOOL.....	92
REGULATOR.....	132
REMOTE SWITCH.....	133
RIM LOCKS.....	99
RIMS.....	98/99
RUBBER MANIFOLD SET .....	126
RUBBER MAT .....	57

## S

SEAL FOR FUEL TANK CAP.....	83
SEAL FOR STEERING STEM.....	80
SEATS .....	82
SHAFT .....	122
SHIFT LEVERS.....	105
SHOCK ABSORBERS .....	94/111
SHOCK ABSORBERS REPAIR KIT.....	111
SHOCK ABSORBERS SPACER KIT.....	111
SHOCK ABSORBERS SPRING .....	94
SIDE PLATES.....	66/69
SKID PLATE .....	104
SLEEVE FOR CARBURETOR .....	126
SLOW JET.....	125
SPACERS .....	94/100
SPACERS FOR BAR MOUNT .....	79
SPARK ARRESTOR .....	128
SPARK PLUG REMOVAL TOOL .....	108
SPARK PLUGS .....	133
SPOKE SKINS.....	99
SPOKE TOOL.....	108
SPOKES .....	99
SPROCKETS.....	106/107
SPROCKET GUARD .....	107
SPROCKET LOCKING TAB .....	107
STABILIZED WHEEL KIT .....	14
STAND SCREW & NUT .....	81
STANDARD LEVERS .....	77
STARTER CHAIN .....	120
STARTER RELAY .....	132
STICKER SHEET (YCF) .....	65
SUBFRAMES .....	81
SUPERMOTARD CATCH TANK KIT .....	105
SUPERMOTARD RACING PARTS.....	112-115
SUPERMOTARD TEFLON PROTECTION SET .....	105

SUPPORTING PLATE FOR HOUR METER .....	133
SWING ARMS .....	92
SWING ARM SLIDER .....	93
SWITCH REMOTE CUT OFF (50CC) .....	133

## T

TAIL LIGHT .....	72
TANK BOLT.....	125
TANK COVER .....	83
TANK SHROUDS.....	66/69
TANK RECUPERATOR OIL.....	104
TAPER ROLLER BEARINGS .....	80
THREADLOCK.....	108
THROTTLE ADJUSTING SCREW.....	76
THROTTLE ASSEMBLY.....	77
THROTTLE CABLES .....	77
THROTTLE HANDLE.....	76
TIMING SPROCKET.....	120/134
TIRES.....	102/103
TIRE LEVER .....	108
TIRE VALVE CAPS .....	102
TIRE VALVE INNER .....	95
TOOLS .....	108/110
TRACK TAPE .....	56
TRAINING WHEEL KIT .....	14
TRANSPORT BAG.....	59
TRIPLE CLAMPS.....	78/79
T-SHIRTS .....	58
TUBES .....	14/102

## U

UMBRELLA .....	58
----------------	----

## V

VALVE ADJUSTMENT TOOL.....	108
VALVE PLUG.....	102
VALVE STEM SEAL.....	122

## W

WASHER FOR STEERING STEM NUT.....	80
WHEEL ASSEMBLY (COMPLETE) .....	14/95-98
WIRING HARNESS .....	132

## Y

YCF PLASTIC HANDLES ON SIDE PLATES.....	67/70
---	-------



┌

┌



**LITE**

┌

l : 740mm/ w: 29 in.

┌

l : 740mm/ w: 29 in.

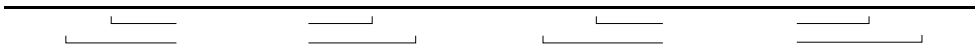

**FACTORY**

┌

┌



# START

**START F88SE**

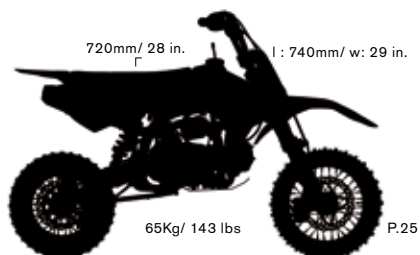

**START F125  
START F125SE**

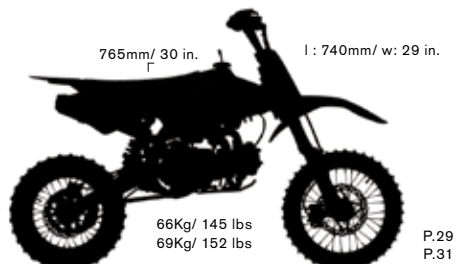

# W88 ELECTRIC MOTOR

**START W88**



# PILOT

**PILOT F125**

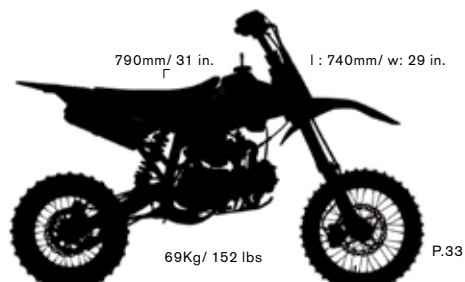

**PILOT F150E**

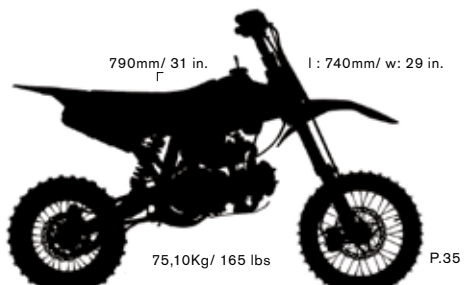

# SM

**SM F125**

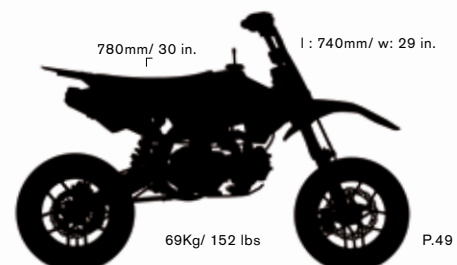

**SM F155  
SM F190**

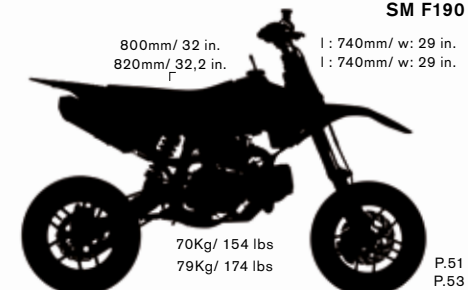

# BIGY

**BIGY F125 MX  
BIGY F150 MX**

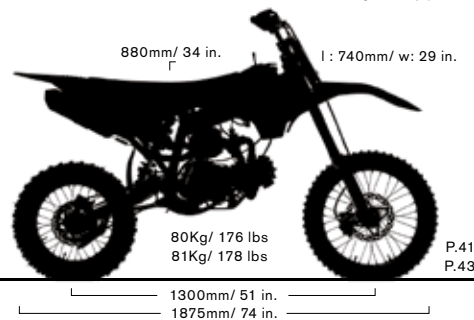

**BIGY F150 MX-E FACTORY  
BIGY F190 MX FACTORY DAYTONA®**

# FACTORY

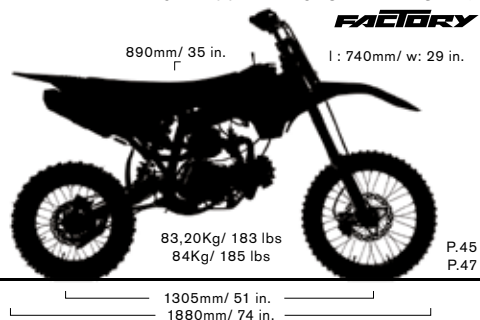

**BIGY SM F190 DAYTONA®**

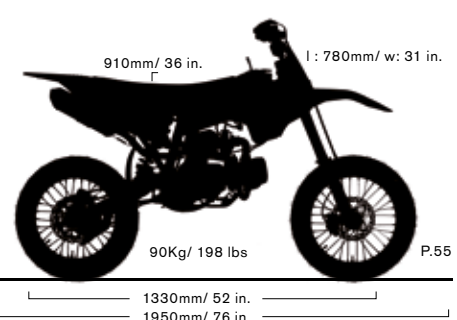



DISPONIBLE/ AVAILABLE PAGE 14

€ 1349

**SPÉCIFICATIONS**

**MOTEUR: MONO CYLINDRE REFROIDISSEMENT À AIR/ AUTOMATIQUE**  
**FOURCHE INVERSÉE 530mm**  
**SUSPENSION ARRIÈRE 200mm**  
**PNEUS AV. & AR. : 2.50/10 - 2.50/10**

**SPECIFICATIONS**

ENGINE TYPE: SINGLE CYLINDER AIR COOLING/ AUTOMATIC GEAR BOX  
 530mm UPSD FORK  
 200mm REAR SUSPENSION  
 FRONT & REAR TIRES: 2.50/10 - 2.50/10

**2023 YCF 50 A FUN FANATIC**

**POINTS FORTS & NOUVEAUTÉS 2023**

**MOTEUR 4T 50CC**  
**STARTER AU GUIDON**  
**DÉMARREUR ÉLECTRIQUE**  
**PRISE RAPIDE DE CHARGEUR DE BATTERIE**  
**POIGNÉE GAZ RÉGLABLE**  
**42 KGS SEULEMENT**  
**CLÉ DE CONTACT ÉTANCHE**  
**FREIN AVANT ET FREIN ARRIÈRE HYDRAULIQUE**  
**NOUVEAU RÉSERVOIR**  
**TÉ FOURCHE SUPÉRIEUR 3 POSITIONS**

**HIGHLIGHTS & 2023 NEW FEATURES**

50CC 4 STROKE ENGINE  
 START BUTTON  
 ELECTRIC START  
 FAST BATTERY CHARGING  
 ADJUSTABLE THROTTLE  
 ONLY 92 LBS IN WEIGHT  
 WATERPROOF KEY CONTACTOR  
 HYDRAULIC BRAKE SYSTEM  
 NEW TANK  
 UPPER CLAMP 3 POSITIONS BAR MOUNT



**YCF 50A**



550mm/ 21 in.

 **42Kg/ 92 lbs**

L : 580mm/ W: 23 in.

870mm/ 34 in.

1270mm/ 50 in.



DISPONIBLE/ AVAILABLE PAGE 14

€ 1699

**SPÉCIFICATIONS**

**MOTEUR: ÉLECTRIQUE 1200W**  
**BATTERIE LITHIUM 10aH**  
**FOURCHE INVERSÉE 530mm**  
**SUSPENSION ARRIÈRE 200mm**  
**PNEU AV. & ARR.: 2.50/10 - 2.50/ 10**

**SPECIFICATIONS**

1200W ELECTRIC  
 10 Ah LITHIUM BATTERY  
 530mm UPSD FORK  
 200mm REAR SUSPENSION  
 FRONT & REAR TIRES: 2.50/10 - 2.50/ 10

**2023 YCF 50 E**  
**SILENCE BUILT TO PERFECTION**

**POINTS FORTS & NOUVEAUTÉS 2023**

**MOTEUR ÉLECTRIQUE NÉODYMIUM MAGNET DC 1200W/ 48V**  
**BATTERIE LITHIUM/ TEMPS DE CHARGE 6H**  
**AUTONOMIE 1H30**  
**CHARGEUR LI-ION 110V/ 220V**  
**RÉGLAGE PARENTAL (POTENTIOMÈTRE)**  
**POIGNÉE GAZ INDICATEUR CHARGE BATTERIE**  
**36KG SEULEMENT**  
**RÉGLAGE DU TEMPS DE RÉPONSE À L'ACCÉLÉRATION**  
**FREIN AVANT ET FREIN ARRIÈRE HYDRAULIQUE**  
**NOUVEAU RÉSERVOIR**  
**TÉ FOURCHE SUPÉRIEUR 3 POSITIONS**

**HIGHLIGHTS & 2023 NEW FEATURES**

1200W/ 48V NEODYMIUM MAGNET DC ENGINE  
 LITHIUM BATTERY/ CHARGING TIME 6 HOURS  
 BATTERY LIFE 1H30  
 LI-ION BATTERY CHARGER 110V/ 220V  
 SPEED DIAL (POTENTIOMETER)  
 THROTTLE WITH BATTERY CHARGE INDICATOR  
 ONLY 79 LBS IN WEIGHT  
 ACCELERATION RESPONSE TIME ADJUSTMENT  
 HYDRAULIC BRAKE SYSTEM  
 NEW TANK  
 UPPER CLAMP 3 POSITIONS BAR MOUNT



**YCF 50 E**



550mm/ 21 in.

 **36Kg/ 79 lbs**

L : 580mm/ W: 23 in.

870mm/ 34 in.

1270mm/ 50 in.



**KIT STABILISATEUR POUR YCF 50**  
STABILIZER WHEEL KIT FOR YCF 50

N° YC50-2105

€ 109

**ROUE POUR KIT STABILISATEUR**  
WHEEL FOR STABILIZER WHEEL KIT

01 N° YC50-2101

€ 25

**CHAMBRE À AIR POUR KIT STABILISATEUR**  
TUBE FOR STABILIZER WHEEL KIT

03 N° YC50-2106

€ 8

**GARDE BOUE POUR KIT STABILISATEUR**  
MUDGUARD FOR STABILIZER WHEEL KIT

02 N° YC50-2103 (GAUCHE/ LEFT)  
02 N° YC50-2104 (DROIT/ RIGHT)

€ 25



PAGE 83

PAGE 77

PAGE 77

PAGE 102





PAGE 71

PAGE 83

PAGE 80

PAGE 133

PAGE 107

PAGE 83

PAGE 75



€ 1199

#### SPÉCIFICATIONS

**MOTEUR: MONO CYLINDRE 4 TEMPS 88cc**  
**4 VITESSES EMBRAYAGE SEMI AUTOMATIQUE**  
**FOURCHE 600mm**  
**SUSPENSION ARRIÈRE 265mm**  
**PNEUS AV. & AR. : 250/10 - 300/10**

#### SPECIFICATIONS

ENGINE TYPE: SINGLE CYLINDER 4 STROKE 88cc  
4 GEARS (N1234) WITH AUTOMATIC CLUTCH  
600mm FORK  
265mm REAR SUSPENSION  
FRONT & REAR TIRES: 250/10 - 300/10

## 2023 LITE F88S LIGHT IS RIGHT!

#### POINTS FORTS & NOUVEAUTÉS 2023

**POIGNÉE DE GAZ RÉGLABLE**  
**SEMI-AUTOMATIQUE**  
**SELLE BASSE COMPATIBLE PAGE 82**  
**FILTRE À AIR YCF**  
**POIGNÉE CAOUTCHOUC YCF**  
**KIT RABASSE AMORTISSEUR PAGE 94**  
**NOUVEAU RÉSERVOIR**  
**NOUVEAU CARTER ALLUMAGE**  
**NOUVEAU SABOT MOTEUR**  
**TÉ FOURCHE SUPÉRIEUR 3 POSITIONS**

#### HIGHLIGHTS & 2023 NEW FEATURES

ADJUSTABLE THROTTLE  
SEMI-AUTOMATIC  
COMPATIBLE LOW SEAT PAGE 82  
YCF AIR FILTER  
YCF GRIPS  
HEIGHT ADJUSTMENT KIT PAGE 94  
NEW TANK  
NEW IGNITION COVER  
NEW SKID PLATE  
UPPER CLAMP 3 POSITIONS BAR MOUNT

**LITE**

**F885**



710mm/ 28 in.

 60Kg/ 132 lbs

L : 740mm/ W: 29 in.

1083mm/ 42 in.

1500mm/ 59 in.



€ 1249

#### SPÉCIFICATIONS

**MOTEUR: MONO CYLINDRE 4 TEMPS 125cc**  
**4 VITESSES EMBRAYAGE**  
**FOURCHE 650mm**  
**SUSPENSION ARRIÈRE 270mm**  
**PNEUS AV. & AR. : 60/100/14 - 80/100/12**

#### SPECIFICATIONS

ENGINE TYPE: SINGLE CYLINDER 4 STROKE 125cc  
4 GEARS (N1234)  
650mm FORK  
270mm REAR SUSPENSION  
FRONT & REAR TIRES: 60/100/14 - 80/100/12

## 2023 LITE F125 LIGHT? YOU BET!

#### POINTS FORTS & NOUVEAUTÉS 2023

**POIGNÉE DE GAZ RÉGLABLE**  
**EMBRAYAGE MANUEL**  
**SELLE BASSE COMPATIBLE PAGE 82**  
**FILTRE À AIR YCF**  
**POIGNÉE CAOUTCHOUC YCF**  
**KIT RABASSE AMORTISSEUR PAGE 94**  
**NOUVEAU RÉSERVOIR**  
**NOUVEAU CARTER ALLUMAGE**  
**NOUVEAU SABOT MOTEUR**  
**NOUVEAU LEVIER EMBRAYAGE ET COCOTTE**  
**TÉ FOURCHE SUPÉRIEUR 3 POSITIONS**

#### HIGHLIGHTS & 2023 NEW FEATURES

ADJUSTABLE THROTTLE  
MANUAL CLUTCH  
COMPATIBLE LOW SEAT PAGE 82  
YCF AIR FILTER  
YCF GRIPS  
HEIGHT ADJUSTMENT KIT PAGE 94  
NEW TANK  
NEW IGNITION COVER  
NEW SKID PLATE  
NEW CLUTCH LEVER AND BRACKET  
UPPER CLAMP 3 POSITIONS BAR MOUNT

**LITE**

**F125**



750mm / 30 in.

 63Kg / 139 lbs

L : 740mm / W : 29 in.

1110mm / 44 in.

1590mm / 62 in.



€ 1749

#### SPÉCIFICATIONS

**MOTEUR: MONO CYLINDRE 4 TEMPS 110cc**  
**4 VITESSES EMBRAYAGE SEMI AUTOMATIQUE**  
**FOURCHE 650mm**  
**SUSPENSION ARRIÈRE DNM 270mm**  
**PNEUS AV. & AR.: 60/100/14 - 80/100/12**

#### SPECIFICATIONS

ENGINE TYPE: SINGLE CYLINDER 4 STROKE 110cc  
4 GEARS (N1234) WITH AUTOMATIC CLUTCH  
650mm FORK  
DNM 270mm REAR SUSPENSION  
FRONT & REAR TIRES: 60/100/14 - 80/100/12



## 2023 LITE F110R SE STOCK CLASS

#### POINTS FORTS & NOUVEAUTÉS 2023

**DÉMARREUR ÉLECTRIQUE**  
**SEMI-AUTOMATIQUE**  
**CERCEAU ALUMINIUM**  
**REPOSE PIED INOX**  
**GUIDON ALUMINIUM**  
**PÉDALE DE FREIN ALUMINIUM**  
**AMORTISSEUR DNM**  
**NOUVEAU RÉSERVOIR**  
**NOUVEAU CARTER ALLUMAGE**

#### HIGHLIGHTS & 2023 NEW FEATURES

ELECTRIC STARTER  
SEMI-AUTOMATIC  
ALUMINUM RIM  
INOX FOOTPEGS  
ALUMINUM HANDLEBAR  
ALUMINUM BRAKE PEDAL  
DNM SHOCK ABSORBER  
NEW TANK  
NEW IGNITION COVER

**LITE**

**F110 R54**



750mm/ 30 in.

 **63Kg/ 139 lbs**

L : 740mm/ W: 29 in.

1110mm/ 44 in.

1590mm/ 62 in.



€ 1799

#### SPÉCIFICATIONS

**MOTEUR: MONO CYLINDRE 4 TEMPS 110cc FIDDY RACER  
4 VITESSES**  
**FOURCHE 650mm**  
**SUSPENSION ARRIÈRE DNM 270mm**  
**PNEUS AV. & AR.: 60/100/14 - 80/100/12**

#### SPECIFICATIONS

ENGINE TYPE: FIDDY RACER SINGLE CYLINDER 4 STROKE 110cc  
4 GEARS (N1234)  
650mm FORK  
DNM 270mm REAR SUSPENSION  
FRONT & REAR TIRES: 60/100/14 - 80/100/12

## 2023 LITE F110R STOCK CLASS, CLUTCH

#### POINTS FORTS & NOUVEAUTÉS 2023

**MOTEUR 110cc FIDDY RACER**  
**CERCEAU ALUMINIUM**  
**REPOSE PIED INOX**  
**GUIDON ALUMINIUM**  
**PÉDALE DE FREIN ALUMINIUM**  
**AMORTISSEUR DNM**  
**NOUVEAU RÉSERVOIR**  
**NOUVEAU CARTER ALLUMAGE**  
**NOUVEAU SABOT MOTEUR**

#### HIGHLIGHTS & 2023 NEW FEATURES

FIDDY RACER POWERFUL 110cc ENGINE  
ALUMINUM RIM  
INOX FOOTPEGS  
ALUMINUM HANDLEBAR  
ALUMINUM BRAKE PEDAL  
DNM SHOCK ABSORBER  
NEW TANK  
NEW IGNITION COVER  
NEW SKID PLATE



**LITE**

**F110R**



750mm/ 30 in.

 63Kg/ 139 lbs

L : 740mm/ W: 29 in.

1110mm/ 44 in.

1590mm/ 62 in.



€ 1599

#### SPÉCIFICATIONS

**MOTEUR: MONO CYLINDRE 4 TEMPS 88cc**  
**4 VITESSES EMBRAYAGE SEMI AUTOMATIQUE**  
**FOURCHE INVERSÉE 600mm**  
**SUSPENSION ARRIÈRE RÉGLABLE 265mm**  
**PNEUS AV. & AR. : 60/100/12 - 300/10**

#### SPECIFICATIONS

ENGINE TYPE: SINGLE CYLINDER 4 STROKE 88cc  
4 GEARS (N1234) WITH AUTOMATIC CLUTCH  
600mm UPSD FORK  
265mm ADJUSTABLE REAR SUSPENSION  
FRONT & REAR TIRES: 60/100/12 - 300/10

## 2023 START F88SE MAGIC BUTTON

#### POINTS FORTS & NOUVEAUTÉS 2023

**DÉMARREUR ÉLECTRIQUE SEMI-AUTOMATIQUE**  
**POIGNÉE DE GAZ RÉGLABLE**  
**BOUTON DE DÉMARREUR ÉTANCHE**  
**SELLE BASSE COMPATIBLE PAGE 82**  
**FILTRE À AIR YCF**  
**POIGNÉE CAOUTCHOUC YCF**  
**TÉ FOURCHE SUPÉRIEUR 3 POSITIONS**  
**NOUVEAU RÉSERVOIR**

#### HIGHLIGHTS & 2023 NEW FEATURES

ELECTRIC STARTER  
SEMI-AUTOMATIC  
ADJUSTABLE THROTTLE  
WATERPROOF START BUTTON  
COMPATIBLE LOW SEAT PAGE 82  
YCF AIR FILTER  
YCF GRIPS  
UPPER CLAMP 3 POSITIONS BAR MOUNT  
NEW TANK

**START**

**F885**



720mm/ 28 in.

 65Kg/ 143 lbs

L : 740mm/ W: 29 in.

1045mm/ 41 in.

1460mm/ 57 in.



€ 2499

**SPÉCIFICATIONS**

**MOTEUR: ÉLECTRIQUE 1000W/ 60V**  
**BATTERIE LITHIUM 20Ah**  
**FOURCHE INVERSÉE 600mm**  
**Suspension ARRIÈRE RÉGLABLE 265mm**  
**PNEUS AV. & AR. : 60/100/12 - 300/10**

**SPECIFICATIONS**

ENGINE TYPE: 1000W/ 60V ELECTRIC  
 20Ah LITHIUM BATTERY  
 600mm UPSD FORK  
 265mm ADJUSTABLE REAR SUSPENSION  
 FRONT & REAR TIRES: 60/100/12 - 300/10

**2023 START W88**  
**THE NEW ERA OF ELECTRIC**

**POINTS FORTS & NOUVEAUTÉS 2023**

**MOTEUR BRUSHLESS 1000W/ 60V**  
**BATTERIE LITHIUM/ TEMPS DE CHARGE 4H**  
**AUTONOMIE 1H00**  
**CHARGEUR RAPIDE LI-ION 110V/ 240V**  
**POIGNÉE DE GAZ AVEC INDICATEUR DE CHARGE DE BATTERIE**  
**54,5 KG SEULEMENT**  
**PROTECTION MOTEUR/ BATTERIE PAR CAISSON FIBRE DE VERRE**  
**RÉGLAGE 3 VITESSES**  
**SELLE BASSE COMPATIBLE PAGE 82**  
**KIT RABAISSE ADAPTABLE PAGE 94**  
**TÉ FOURCHE SUPÉRIEUR 3 POSITIONS**  
**CHAÎNE-COURONNE-PSB EN 420**

**HIGHLIGHTS & 2023 NEW FEATURES**

1000W/ 60V BRUSHLESS ENGINE (BDLC)  
 LITHIUM BATTERY/ CHARGING TIME 4 HOURS  
 BATTERY LIFE 1:00  
 LI-ION BATTERY FAST CHARGER 110V/ 240V  
 THROTTLE WITH BATTERY CHARGE INDICATOR  
 ONLY 119 LBS IN WEIGHT  
 FIBER GLASS FULL COVERAGE OF THE ENGINE  
 ADJUSTABLE 3 SPEEDS  
 COMPATIBLE LOW SEAT PAGE 82  
 HEIGHT ADJUSTMENT KIT PAGE 94  
 UPPER CLAMP 3 POSITIONS BAR MOUNT  
 SPROCKET-CHAIN 420

**START**

**WEBB** ELECTRIC MOTOR



715mm/ 28 in.

 54,5Kg/ 119 lbs

L : 740mm/ W: 29 in.

1045mm/ 41 in.

1470mm/ 58 in.



€ 1499

**SPÉCIFICATIONS**

**MOTEUR: MONO CYLINDRE 4 TEMPS 125cc**  
**4 VITESSES EMBRAYAGE**  
**FOURCHE INVERSÉE 660mm**  
**SUSPENSION ARRIÈRE RÉGLABLE 270mm**  
**PNEUS AV. & AR.: 60/100/14 - 80/100/12**

**SPECIFICATIONS**

ENGINE TYPE: SINGLE CYLINDER 4 STROKE 125cc  
 4 GEARS (N1234)  
 660mm UPSD FORK  
 270mm ADJUSTABLE REAR SUSPENSION  
 FRONT & REAR TIRES: 60/100/14 - 80/100/12

**2023 START F125**  
**FAST & EASY**

**POINTS FORTS & NOUVEAUTÉS 2023**

**POIGNÉE DE GAZ RÉGLABLE**  
**JOINT ÉTANCHE DE COLONNE DE DIRECTION**  
**SELLE BASSE COMPATIBLE PAGE 82**  
**KIT RABAISSE ADAPTABLE PAGE 94**  
**FILTRE À AIR YCF**  
**POIGNÉE CAOUTCHOUC YCF**  
**TÉ FOURCHE SUPÉRIEUR 3 POSITIONS**  
**NOUVEAU RÉSERVOIR**  
**NOUVEAU CARTER ALLUMAGE**  
**NOUVEAU SABOT MOTEUR**

**HIGHLIGHTS & 2023 NEW FEATURES**

ADJUSTABLE THROTTLE  
 SEALING WASHER FOR STEERING STEM  
 COMPATIBLE LOW SEAT PAGE 82  
 HEIGHT ADJUSTMENT KIT PAGE 94  
 YCF AIR FILTER  
 YCF GRIPS  
 UPPER CLAMP 3 POSITIONS BAR MOUNT  
 NEW TANK  
 NEW IGNITION COVER  
 NEW SKID PLATE

**START**

**F125**

765mm/ 30 in.



 66Kg/ 145 lbs

L : 740mm/ W: 29 in.

1120mm/ 44 in.

1595mm/ 62 in.

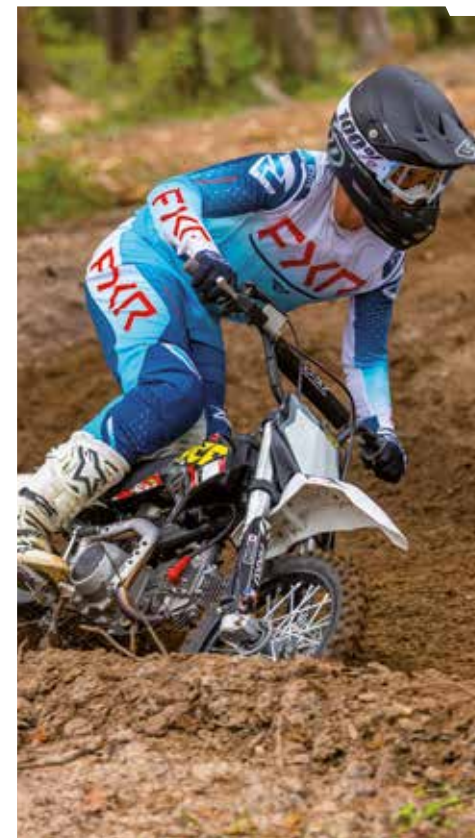

€ 1649

**SPÉCIFICATIONS**

**MOTEUR: MONO CYLINDRE 4 TEMPS 125cc**  
**4 VITESSES EMBRAYAGE SEMI AUTOMATIQUE**  
**FOURCHE INVERSÉE 660mm**  
**SUSPENSION ARRIÈRE RÉGLABLE 270mm**  
**PNEUS AV. & AR.: 60/100/14 - 80/100/12**

**SPECIFICATIONS**

ENGINE TYPE: SINGLE CYLINDER 4 STROKE 125cc  
 4 GEARS (N1234) WITH AUTOMATIC CLUTCH  
 660mm UPSD FORK  
 270mm ADJUSTABLE REAR SUSPENSION  
 FRONT & REAR TIRES: 60/100/14 - 80/100/12

**2023 START F125SE**  
**THE ULTIMATE BATTLE MACHINE**

**POINTS FORTS & NOUVEAUTÉS 2023**

**DÉMARREUR ÉLECTRIQUE**  
**SEMI-AUTOMATIQUE**  
**POIGNÉE DE GAZ RÉGLABLE**  
**SELLE BASSE COMPATIBLE PAGE 82**  
**FILTRE À AIR YCF**  
**POIGNÉE CAOUTCHOUC YCF**  
**TÉ FOURCHE SUPÉRIEUR 3 POSITIONS**  
**NOUVEAU RÉSERVOIR**

**HIGHLIGHTS & 2023 NEW FEATURES**

ELECTRIC START  
 SEMI-AUTOMATIC  
 ADJUSTABLE THROTTLE  
 COMPATIBLE LOW SEAT PAGE 82  
 YCF AIR FILTER  
 YCF GRIPS  
 UPPER CLAMP 3 POSITIONS BAR MOUNT  
 NEW TANK



**START**

**F125S**



765mm/ 30 in.

 69Kg/ 152 lbs

L : 740mm/ W: 29 in.

1120mm/ 44 in.

1595mm/ 62 in.



€ 1799

**SPÉCIFICATIONS**

**MOTEUR: MONO CYLINDRE**  
**4 TEMPS 125cc/ 4 VITESSES**  
**FOURCHE INVERSÉE 735mm**  
**SUSPENSION ARRIÈRE RÉGLABLE 330mm**  
**PNEUS AV. & AR.: 60/100/14 - 80/100/12**

**SPECIFICATIONS**

ENGINE TYPE: SINGLE CYLINDER  
 4 STROKE 125cc/ 4 GEARS (N1234)  
 FORK: 735mm UPSD FORK  
 REAR SUSPENSION: 330mm ADJUSTABLE  
 FRONT & REAR TIRES: 60/100/14 - 80/100/12

**2023 PILOT F125**  
**WORLD CLASS SIZE**

**POINTS FORTS & NOUVEAUTÉS 2023**

**BOÎTE À AIR**  
**POIGNÉE CAOUTCHOUC YCF**  
**TÉ FOURCHE SUPÉRIEUR 3 POSITIONS**  
**MOTEUR 125 ZONGSHEN FIDDY RACER**  
**CARBURATEUR NIBBI PE24SP**  
**NOUVEAU RÉSERVOIR**  
**NOUVEAU CARTER ALLUMAGE**  
**NOUVEAU SABOT MOTEUR**

**HIGHLIGHTS & 2023 NEW FEATURES**

AIR BOX  
 YCF GRIPS  
 UPPER CLAMP 3 POSITIONS BAR MOUNT  
 ZONGSHEN 125 FIDDY RACER ENGINE  
 NIBBI PE24SP CARBURETOR  
 NEW TANK  
 NEW IGNITION COVER  
 NEW SKID PLATE

# PILOT

# F125



790mm/ 31 in.

 69Kg/ 152 lbs

L : 740mm/ W: 29 in.

1170mm/ 46 in.

1645mm/ 64 in.



€ 1949

#### SPÉCIFICATIONS

**MOTEUR: MONOCYLINDRE 4 TEMPS**  
150cc/ 4 VITESSES (N1234)  
**FOURCHE INVERSÉE 735mm**  
**SUSPENSION ARRIÈRE RÉGLABLE 330mm**  
**PNEUS AV. & AR. : 60/100/14 - 80/100/12**

#### SPECIFICATIONS

ENGINE TYPE: SINGLE CYLINDER 4 STROKE  
150cc/ 4 GEARS (N1234)  
735mm UPSD FORK  
330mm ADJUSTABLE REAR SUSPENSION  
FRONT & REAR TIRES: 60/100/14 - 80/100/12

## 2023 PILOT F150 ⚡ THE ULTIMATE 150 ⚡

#### POINTS FORTS & NOUVEAUTÉS 2023

**BOÎTE À AIR**  
**POIGNÉE CAOUTCHOUC YCF**  
**TÉ FOURCHE SUPÉRIEUR 3 POSITIONS**  
**DÉMARREUR ELECTRIQUE**  
**CARBURATEUR NIBBI PE24SP**  
**NOUVEAU RÉSERVOIR**

#### HIGHLIGHTS & 2023 NEW FEATURES

AIR BOX  
YCF GRIPS  
UPPER CLAMP 3 POSITIONS BAR MOUNT  
ELECTRIC START  
NIBBI PE24SP CARBURETOR  
NEW TANK

**PILOT**

**F150**



790mm / 31 in.

 75,10Kg / 165 lbs

L : 740mm / W: 29 in.

1170mm / 46 in.

1645mm / 64 in.



€ 2499

#### SPÉCIFICATIONS

**MOTEUR: MONOCYLINDRE 4 TEMPS**  
**150cc TYPE KLX/ 4 VITESSES**  
**FOURCHE INVERSÉE RÉGLABLE 735mm**  
**SUSPENSION ARRIÈRE RÉGLABLE 330mm**  
**PNEUS AV. & AR.: 60/100/14 - 80/100/12 ARRO®**

#### SPECIFICATIONS

ENGINE TYPE: SINGLE CYLINDER 4 STROKE  
 150cc KLX TYPE/ 4 GEARS (N1234)  
 735mm ADJUSTABLE UPSD FORK  
 330mm ADJUSTABLE REAR SUSPENSION  
 FRONT & REAR TIRES: 60/100/14 - 80/100/12 ARRO®

## 2023 FACTORY SP2 150 RACE READY

#### POINTS FORTS & NOUVEAUTÉS 2023

**MOYEURS AVANT/ ARRIÈRE ALUMINIUM CNC**  
**COURONNE 5 TROUS**  
**PNEUS ARRO® AVANT/ ARRIÈRE**  
**CERCEAU DE ROUE ALUMINIUM 7116 NOIR**  
**GRAISSEUR SUR COLONNE DE DIRECTION**  
**SILENCIEUX RACING**  
**POIGNÉE CAOUTCHOUC YCF**  
**BAVETTE AMORTISSEUR**  
**TÉ FOURCHE SUPÉRIEUR 3 POSITIONS**  
**BRAS OSCILLANT ALUMINIUM 420mm**  
**CARBURATEUR NIBBI PE24SP**  
**NOUVEAU RÉSERVOIR**  
**NOUVEAU CARTER ALLUMAGE**

#### HIGHLIGHTS & 2023 NEW FEATURES

ALUMINIUM CNC FRONT/ REAR HUBS  
 REAR SPROCKET 5 FIXATIONS POINTS  
 FRONT/ REAR ARRO® TIRES  
 ALUMINIUM 7116 BLACK RIMS  
 GREASING ON STEERING STEM  
 RACING MUFFLER  
 YCF GRIPS  
 MUD FLAP  
 UPPER CLAMP 3 POSITIONS BAR MOUNT  
 420mm ALUMINIUM SWING ARM  
 NIBBI PE24SP CARBURETOR  
 NEW TANK  
 NEW IGNITION COVER

**FACTORY**

**150 SP2**



800mm / 32 in.

 **73Kg / 161 lbs**

L : 740mm / W: 29 in.

1190mm / 47 in.

1670mm / 66 in.



€ 3499

**SPÉCIFICATIONS**

**MOTEUR: MONO CYLINDRE 4T, 4 SOUPAPES 190cc**  
**DAYTONA® ANIMA® / 4 VITESSES**  
**FOURCHE ENGI® INVERSÉE RÉGLABLE 800mm**  
**SUSPENSION ARRIÈRE ENGI® RÉGLABLE 335mm**  
**PNEUS AV. & AR. ARRO® : 60/100/14 - 80/100/12**  
**CARBURATEUR NIBBI® 28**

**SPECIFICATIONS**

ENGINE TYPE: DAYTONA® ANIMA® SINGLE CYLINDER 4V  
 4 STROKE 190cc/ 4 GEARS (N1234)  
 800mm ENGI® UPSD ADJUSTABLE FORK  
 335mm ENGI® ADJUSTABLE REAR SUSPENSION  
 FRONT & REAR ARRO® TIRES: 60/100/14 - 80/100/12  
 NIBBI® 28 CARBURETOR

**DAYTONA ENGI® ARRO™**

**2023 FACTORY SP3 190**  
**CATCH ME IF YOU CAN**

**POINTS FORTS & NOUVEAUTÉS 2023**

**BRAS OSCILLANT 460mm**  
**TÉ 170mm**  
**MOYEURS AVANT/ ARRIÈRE ALUMINIUM CNC**  
**POIGNÉE CAOUTCHOUC YCF**  
**BAVETTE AMORTISSEUR**  
**GUIDON YCF 28,6MM**  
**REPOSE PIED INOX**  
**PÉDALE DE FREIN ALUMINIUM**  
**GUIDE CHAÎNE RENFORCÉ**  
**TÉ FOURCHE SUPÉRIEUR 3 POSITIONS**  
**NOUVEAU RÉSERVOIR**  
**NOUVEAU CARTER ALLUMAGE**

**HIGHLIGHTS & 2023 NEW FEATURES**

460mm SWINGARM  
 170mm TRIPLE CLAMPS  
 ALUMINIUM CNC FRONT/ REAR HUBS  
 YCF GRIPS  
 MUD FLAP  
 YCF FAT BAR 28,6mm HANDLEBAR  
 INOX FOOT PEGS  
 ALUMINIUM BRAKE PEDAL  
 REINFORCED CHAIN GUIDE  
 UPPER CLAMP 3 POSITIONS BAR MOUNT  
 NEW TANK  
 NEW IGNITION COVER



**FACTORY**

**190 SP3**  
**DAYTONA**



845mm / 33 in.

 **75Kg / 165 lbs**

L : 740mm / W: 29 in.

1195mm / 47 in.

1670mm / 66 in.



€ 2149

#### SPÉCIFICATIONS

**MOTEUR: MONO CYLINDRE**  
**4 TEMPS 125cc/ 4 VITESSES**  
**FOURCHE INVERSÉE 785mm**  
**SUSPENSION ARRIÈRE RÉGLABLE 355mm**  
**PNEUS AV. & AR. : 70/100/17 - 90/100/14**

#### SPECIFICATIONS

ENGINE TYPE: SINGLE CYLINDER  
4 STROKE 125cc/ 4 GEARS (N1234)  
FORK: 785mm UPSD FORK  
REAR SUSPENSION: 355mm ADJUSTABLE  
FRONT & REAR TIRES: 70/100/17 - 90/100/14

## 2023 BIGY 125 MX EASY TO PICK UP

#### POINTS FORTS & NOUVEAUTÉS 2023

**ROUE AVANT 17"/ ARRIÈRE 14"**  
**BOÎTE À AIR**  
**POIGNÉE CAOUTCHOUC YCF**  
**BAVETTE AMORTISSEUR**  
**LEVIER DE FREIN PLIABLE**  
**TÉ FOURCHE SUPÉRIEUR 3 POSITIONS**  
**MOTEUR ZONGSHEN 125 FIDDY RACER**  
**CARBURATEUR NIBBI® PE24**  
**NOUVEAU RÉSERVOIR**  
**NOUVEAU CARTER ALLUMAGE**

#### HIGHLIGHTS & 2023 NEW FEATURES

FRONT 17"/ REAR 14" WHEEL  
AIR BOX  
YCF GRIPS  
MUD FLAP  
FOLDABLE FRONT BRAKE LEVER  
UPPER CLAMP 3 POSITIONS BAR MOUNT  
ZONGSHEN 125 FIDDY RACER ENGINE  
NIBBI® PE24 CARBURETOR  
NEW TANK  
NEW IGNITION COVER



**125 MX**



880mm/ 34 in.

 **80Kg/ 176 lbs**

L : 740mm/ W: 29 in.

1300mm/ 51 in.

1875mm/ 74 in.



€ 2299

**SPÉCIFICATIONS**

**MOTEUR: MONO CYLINDRE**  
**4 TEMPS 150cc/ 4 VITESSES**  
**FOURCHE INVERSÉE 785mm**  
**SUSPENSION ARRIÈRE RÉGLABLE 355mm**  
**PNEUS AV. & AR. : 70/100/17 - 90/100/14**

**SPECIFICATIONS**

ENGINE TYPE: SINGLE CYLINDER  
 4 STROKE 150cc/ 4 GEARS (N1234)  
 FORK: 785mm UPSD FORK  
 REAR SUSPENSION: 355mm ADJUSTABLE  
 FRONT & REAR TIRES: 70/100/17 - 90/100/14

**2023 BIGY 150 MX**  
**BIGGER! FASTER! STRONGER!**

**POINTS FORTS & NOUVEAUTÉS 2023**

**ROUE AVANT 17"/ ARRIÈRE 14"**  
**BOÎTE À AIR**  
**POIGNÉE CAOUTCHOUC YCF**  
**BAVETTE AMORTISSEUR**  
**LEVIER DE FREIN PLIABLE**  
**TÉ FOURCHE SUPÉRIEUR 3 POSITIONS**  
**CARBURATEUR NIBBI® PE24**  
**NOUVEAU RÉSERVOIR**  
**NOUVEAU CARTER ALLUMAGE**

**HIGHLIGHTS & 2023 NEW FEATURES**

FRONT 17"/ REAR 14" WHEEL  
 AIR BOX  
 YCF GRIPS  
 MUD FLAP  
 FOLDABLE FRONT BRAKE LEVER  
 UPPER CLAMP 3 POSITIONS BAR MOUNT  
 NIBBI® PE24 CARBURETOR  
 NEW TANK  
 NEW IGNITION COVER



**150 MX**



880mm / 34 in.

 81Kg / 178 lbs

L : 740mm / W: 29 in.

1300mm / 51 in.

1875mm / 74 in.



€ 2899

SPÉCIFICATIONS

**MOTEUR: MONOCYLINDRE 4 TEMPS**  
**150cc YX/ 4 VITESSES**  
**DÉMARREUR ÉLECTRIQUE**  
**FOURCHE INVERSÉE RÉGLABLE 800mm**  
**SUSPENSION ARRIÈRE RÉGLABLE 355mm**  
**PNEUS AV. & AR.: 70/100/17 - 90/100/14 ARRO®**  
**CARBURATEUR NIBBI® 28**

SPECIFICATIONS

ENGINE TYPE: SINGLE CYLINDER 4 STROKE  
 150cc YX/ 4 GEARS  
 ELECTRIC START  
 800mm ADJUSTABLE UPSD FORK  
 355mm ADJUSTABLE REAR SUSPENSION  
 FRONT & REAR TIRES: 70/100/17 - 90/100/14 ARRO®  
 NIBBI® 28 CARBURETOR

**2023 BIGY 150 MX-E ⚡ FACTORY ELECTRIC START**

POINTS FORTS & NOUVEAUTÉS 2023

**ROUE AVANT 17"/ ARRIÈRE 14"**  
**BOÎTE À AIR**  
**JANTES ALUMINIUM 7116**  
**MOYEURS AVANT/ ARRIÈRE ALUMINIUM CNC**  
**POIGNÉE CAOUTCHOUC YCF**  
**BAVETTE AMORTISSEUR**  
**REPOSE PIED INOX**  
**PÉDALE DE FREIN ALUMINIUM**  
**GUIDE CHAÎNE RENFORCÉ**  
**TÉ FOURCHE SUPÉRIEUR 3 POSITIONS**  
**NOUVEAU RÉSERVOIR**

HIGHLIGHTS & 2023 NEW FEATURES

FRONT 17"/ REAR 14" WHEEL  
 AIR BOX  
 ALUMINIUM 7116 RIMS  
 ALUMINIUM FRONT/ REAR CNC HUBS  
 YCF GRIPS  
 MUD FLAP  
 INOX FOOT PEGS  
 ALUMINIUM BRAKE PEDAL  
 REINFORCED CHAIN GUIDE  
 UPPER CLAMP 3 POSITIONS BAR MOUNT  
 NEW TANK



# 150 MXE<sup>+</sup> FACTORY



890mm / 35 in.

 89Kg / 196 lbs

L : 740mm / W : 29 in.

1305mm / 51 in.

1880mm / 74 in.



€ 3599

#### SPÉCIFICATIONS

**MOTEUR: MONO CYLINDRE 4T, 4 SOUPAPES 190cc**  
**DAYTONA® ANIMA® / 4 VITESSES**  
**MOTEUR 4 VITESSES**  
**FOURCHE ENGI® INVERSÉE RÉGLABLE 800mm**  
**SUSPENSION ARRIÈRE ENGI® RÉGLABLE 355mm**  
**PNEUS AV. & AR.: 70/100/17 - 90/100/14 ARRO®**  
**CARBURATEUR NIBBI® 28**

#### SPECIFICATIONS

ENGINE TYPE: DAYTONA® ANIMA® SINGLE CYLINDER 4V  
 4 STROKE 190cc/ 4 GEARS (N1234)  
 4 SPEED ENGINE  
 800mm ENGI® UPSD ADJUSTABLE FORK  
 355mm ENGI® ADJUSTABLE REAR SUSPENSION  
 FRONT & REAR TIRES: 70/100/17 - 90/100/14 ARRO®  
 NIBBI® 28 CARBURETOR

**DAYTONA ENGI® ARRO™**

## 2023 BIGY 190 MX FACTORY DAYTONA FIRST TO THE FINISH LINE

#### POINTS FORTS & NOUVEAUTÉS 2023

**BOÎTE À AIR**  
**SURMOUSSE DE GUIDON CAOUTCHOUC 3D**  
**MOTEUR 4 VITESSES**  
**BRAS OSCILLANT ALUMINIUM**  
**REPOSE PIED INOX**  
**POIGNÉE CAOUTCHOUC YCF**  
**BAVETTE AMORTISSEUR**  
**GUIDON YCF 28,6MM**  
**GUIDE CHAÎNE RENFORCÉ**  
**TÉ FOURCHE SUPÉRIEUR 3 POSITIONS**  
**NOUVEAU RÉSERVOIR**

#### HIGHLIGHTS & 2023 NEW FEATURES

AIR BOX  
 RUBBER BAR PAD  
 DAYTONA 4 SPEED ENGINE  
 ALUMINUM SWING ARM  
 INOX FOOTPEGS  
 YCF GRIPS  
 MUD FLAP  
 YCF FAT BAR 28,6mm HANDLEBAR  
 REINFORCED CHAIN GUIDE  
 UPPER CLAMP 3 POSITIONS BAR MOUNT  
 NEW TANK





# 190 MX **FACTORY** DAYTONA



890mm / 35 in.

 84Kg / 185 lbs

L : 740mm / W: 29 in.

1305mm / 51 in.

1880mm / 74 in.



€ 1999

**SPÉCIFICATIONS**

**MOTEUR: MONO CYLINDRE 4 TEMPS 125cc**  
**4 VITESSES EMBRAYAGE**  
**FOURCHE INVERSÉE 660mm**  
**SUSPENSION ARRIÈRE RÉGLABLE 270mm**  
**PNEUS AV. & AR.: 100/90/12 - 120/80/12**

**SPECIFICATIONS**

ENGINE TYPE: SINGLE CYLINDER 4 STROKE 125cc  
 4 GEARS (N1234)  
 660mm UPSD FORK  
 270mm ADJUSTABLE REAR SUSPENSION  
 FRONT & REAR TIRES: 100/90/12 - 120/80/12

**2023 SM F125  
 SUPERMOTO, SUPER FUN!**

**POINTS FORTS & NOUVEAUTÉS 2023**

**MOTEUR 125 ZONGSHEN FIDDY RACER**  
**PNEUS KENDA K702**  
**ROUES YCF**  
**SELLE BASSE COMPATIBLE PAGE 82**  
**KIT RABAISSÉ ADAPTABLE PAGE 94**  
**POIGNÉE CAOUTCHOUC YCF**  
**TÉ FOURCHE SUPÉRIEUR 3 POSITIONS**  
**CARBURATEUR NIBBI PE24SP**  
**NOUVEAU RÉSERVOIR**  
**NOUVEAU CARTER ALLUMAGE**  
**NOUVEAU SABOT MOTEUR**

**HIGHLIGHTS & 2023 NEW FEATURES**

ZONGSHEN ENGINE 125 FIDDY RACER  
 KENDA TIRES K702  
 YCF WHEELS  
 COMPATIBLE LOW SEAT PAGE 82  
 HEIGHT ADJUSTMENT KIT PAGE 94  
 YCF GRIPS  
 UPPER CLAMP 3 POSITIONS BAR MOUNT  
 NIBBI PE24SP CARBURETOR  
 NEW TANK  
 NEW IGNITION COVER  
 NEW SKID PLATE



**F125**



780mm / 30 in.

 69Kg / 152 lbs

L : 740mm / W: 29 in.

1120mm / 44 in.

1610mm / 63 in.



€ 2399

#### SPÉCIFICATIONS

**MOTEUR: MONO CYLINDRE**  
**4 TEMPS 155cc ZONGSHEN/ 4 VITESSES (N1234)**  
**FOURCHE INVERSÉE 735mm**  
**SUSPENSION ARRIÈRE RÉGLABLE 310mm**  
**PNEUS AV. & AR. : 100/90/12 - 120/80/12**

#### SPECIFICATIONS

ENGINE TYPE: SINGLE CYLINDER  
4 STROKE ZONGSHEN 155cc/ 4 GEARS (N1234)  
735mm UPSD FORK  
310mm ADJUSTABLE REAR SUSPENSION  
FRONT & REAR TIRES: 100/90/12 - 120/80/12

## 2023 SM F155 ADRENALINE RUSH

#### POINTS FORTS & NOUVEAUTÉS 2023

**PNEUS KENDA® K702**  
**MOTEUR ZONGSHEN® W155**  
**ROUES YCF**  
**FILTRE À AIR YCF**  
**FOURCHE RÉGLABLE**  
**POIGNÉE CAOUTCHOUC YCF**  
**TÉ FOURCHE SUPÉRIEUR 3 POSITIONS**  
**CARBURATEUR NIBBI PE24SP**  
**NOUVEAU RÉSERVOIR**  
**NOUVEAU CARTER ALLUMAGE**

#### HIGHLIGHTS & 2023 NEW FEATURES

KENDA® TIRES  
ZONGSHEN® ENGINE W155  
YCF WHEELS  
YCF AIR FILTER  
ADJUSTABLE FRONT FORK  
YCF GRIPS  
UPPER CLAMP 3 POSITIONS BAR MOUNT  
NIBBI PE24SP CARBURETOR  
NEW TANK  
NEW IGNITION COVER



800mm / 32 in.

 70Kg / 154 lbs

L : 740mm / W: 29 in.

1170mm / 46 in.

1680mm / 66 in.



**€ 3249**

**SPÉCIFICATIONS**

**MOTEUR: MONO CYLINDRE 4T, 4 SOUPAPES 190cc**  
**DAYTONA® ANIMA® / 4 VITESSES (N1234)**  
**FOURCHE ENGI® INVERSÉE RÉGLABLE 735mm**  
**SUSPENSION ARRIÈRE DNM® RÉGLABLE 310mm**  
**PNEUS AV. & AR. 100/90/12 - 120/80/12**  
**CARBURATEUR NIBBI® PE28**

**SPECIFICATIONS**

ENGINE TYPE: DAYTONA® ANIMA® SINGLE CYLINDER 4V  
 4 STROKE 190cc/ 4 GEARS (N1234)  
 735mm ENGI® UPSD ADJUSTABLE FORK  
 310mm DNM® ADJUSTABLE REAR SUSPENSION  
 FRONT & REAR TIRES: 100/90/12 - 120/80/12  
 NIBBI® PE28 CARBURETOR

**DAYTONA ENGI® KENDA**

**2023 SM F190**  
**CATCH ME IF YOU CAN (ON ROAD)**

**POINTS FORTS & NOUVEAUTÉS 2023**

**ROUES YCF**  
**PNEUS KENDA® K702**  
**LIGNE D'ÉCHAPPEMENT RACING DOUBLE SORTIE**  
**AMORTISSEUR DNM 1000LBS**  
**MAÎTRE CYLINDRE AVANT RACING**  
**KIT FREIN RADIAL AVANT ET ARRIÈRE**  
**DISQUE FLOTTANT 220MM**  
**TÉ FOURCHE SUPÉRIEUR 3 POSITIONS**  
**NOUVEAU RÉSERVOIR**  
**NOUVEAU CARTER ALLUMAGE**

**HIGHLIGHTS & 2023 NEW FEATURES**

YCF WHEELS  
 KENDA® TIRE K702  
 COMPLETE RACING EXHAUST TWIN  
 DNM SHOCK ABSORBER 1000 LBS  
 FRONT RACING MASTER CYLINDER  
 FRONT AND REAR RADIAL BRAKE KIT  
 SEMI FLOATING BRAKE ROTOR 220MM  
 UPPER CLAMP 3 POSITIONS BAR MOUNT  
 NEW TANK  
 NEW IGNITION COVER



**F190**  
**DAYTONA**



820mm/ 32 in.

 79Kg/ 174 lbs

L : 740mm/ W: 29 in.

1160mm/ 45 in.

1640mm/ 64 in.



€ 3999

#### SPÉCIFICATIONS

**MOTEUR: MONO CYLINDRE 4T, 4 SOUPAPES 190cc**  
**DAYTONA® ANIMA® / 4 VITESSES (N1234)**  
**FOURCHE ENGI® INVERSÉE RÉGLABLE 775mm**  
**SUSPENSION ARRIÈRE DNM® RÉGLABLE 345mm**  
**PNEUS AV. & AR. 110/70/17 - 130/70/17**  
**CERCEAU DE ROUE AV & AR 2.50-17 - 3.00-17**  
**TE FOURCHE 170 mm**  
**CARBURATEUR NIBBI® PE28**

#### SPECIFICATIONS

ENGINE TYPE: DAYTONA® ANIMA® SINGLE CYLINDER 4V  
4 STROKE 190cc/ 4 GEARS (N1234)  
775mm ENGI® UPSD ADJUSTABLE FORK  
345mm DNM® ADJUSTABLE REAR SUSPENSION  
FRONT & REAR TIRES: 110/70/17 - 130/70/17  
FRONT & REAR RIM : 2.50-17 & 3.00-17  
170mm CLAMP  
NIBBI® PE28 CARBURETOR

**DAYTONA ENGI® KENDA**

## 2023 BIGY SM F190 FAST & FURIOUS

#### POINTS FORTS & NOUVEAUTÉS 2023

**ROUES EN 17-17**  
**LIGNE D'ÉCHAPPEMENT RACING DOUBLE SORTIE**  
**AMORTISSEUR DNM 1000LBS**  
**MAÎTRE CYLINDRE AVANT RACING**  
**DISQUE FLOTTANT 220MM**  
**NOUVEAU CARTER ALLUMAGE**

#### HIGHLIGHTS & 2023 NEW FEATURES

17-17 WHEELS  
COMPLETE RACING EXHAUST TWIN  
DNM SHOCK ABSORBER 1000 LBS  
FRONT RACING MASTER CYLINDER  
SEMI FLOATING BRAKE ROTOR 220MM  
NEW IGNITION COVER





910mm / 36 in.

 90Kg / 198 lbs

L : 780mm / W : 31 in.

1330mm / 52 in.

1950mm / 76 in.

**PADDOCK  
PADDOCK**



**ORIFLAMME**  
FLAG

N° YCF-FLAG-3M (3 METERS-118 in.)

€ 129

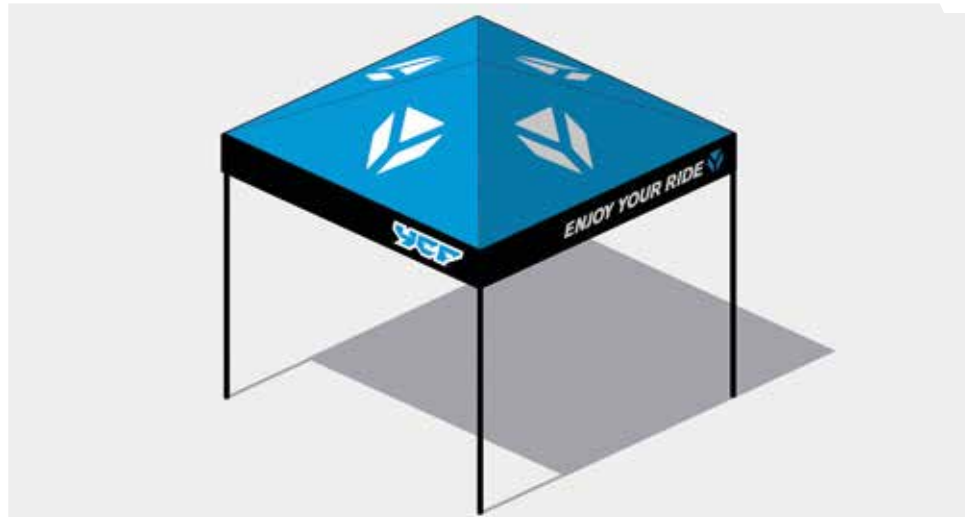

**TONNELLE 3 X 3M YCF (100% ÉTANCHE) VELCRO INTÉGRAL AUTOUR DU TOIT**  
YCF PIT TENT 3 X 3M (100% WATERPROOF) INTEGRAL VELCRO AROUND THE ROOF

N° TONNELLEYCF-4

€ 219



**RUBALISE DE TERRAIN (ROULEAU DE 100 MÈTRES)**  
BANNER ROLL (100 METERS ROLL)

N° RUB-1

€ 9



**BANDEROLE DE TERRAIN EN FEUTRINE 1 X 25M**  
BANNER ROLL 1 X 25M

N° FEUTRINE-2

€ 99



**BANNER YCF 2 X 0,50M**  
YCF BANNER 2 X 0,50M

N° BANNER-01

€ 29



**BÂCHE MOTO**  
MOTORCYCLE COVER

N° BIKECOVER-BL

€ 29

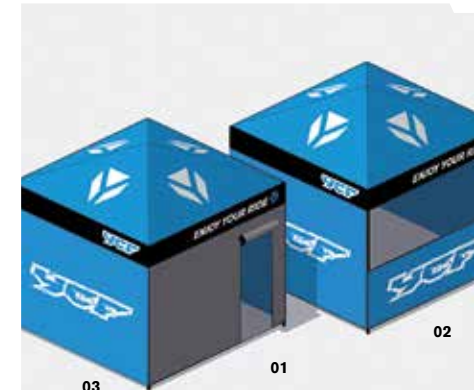

**CÔTÉ DE TONNELLE 3 X 3M AVEC PORTE ZIPPÉE**  
PIT TENT SIDE 3 X 3M WITH ZIP DOOR

01 N° PORTE-1

€ 59

**DEMI CÔTÉ DE TONNELLE**  
PIT TENT HALF SIDE

02 N° DEMICOTE-1-BL

€ 39

**CÔTÉ DE TONNELLE 3 X 3M**  
PIT TENT SIDE 3 X 3M

03 N° COTE-1-BL

€ 49



**CHAISE PLIABLE YCF**  
YCF FOLDING CHAIR

N° CHAIR-BK

€ 29



**TRÉPIED ALUMINIUM NOIR/ BLEU/ VERT/ ORANGE/ ROUGE - HAUTEUR 40 cm**  
ALUMINUM BIKE STAND BLACK/ BLUE/ GREEN/ ORANGE/ RED - HEIGHT 15,7 in.

N° TREPIED-COLOR € 109



**BÉQUILLE ROUE AR RÉGLABLE AVEC ROULETTE**  
REAR STAND. COMES WITH HEIGHT ADJUSTABLE FORKS FOR SPOOLS

N° STAND1MOTO-04 € 59



**TAPIS SOL ENVIRONNEMENTAL YCF 180X80 CM**  
ENVIRONMENTAL YCF RUBBER MAT 180X80 CM (70in x 31 in.)

N° TAPISSOL-4 € 69



**TRÉPIED ACIER NOIR pour 50/88 - HAUTEUR 32 cm**  
50/88 STEEL BIKE STAND BLACK - HEIGHT 12 in.

N° TREPIED02-BK € 59



**TRÉPIED ACIER NOIR - HAUTEUR 40 cm**  
STEEL BIKE STAND BLACK - HEIGHT 15,7 in.

N° TREPIED01-BK € 69



**BÉQUILLE ROUE AR RÉGLABLE**  
ADJUSTABLE REAR WHEEL STAND

N° STAND1MOTO-02 € 39

**TEXTILES  
APPAREL**



**PARAPLUIE YCF**  
YCF UMBRELLA

N° UMBRELLA

€ 29



**BONNET YCF**  
YCF BEANIE

N° BYCF01-BK

€ 15



**BENT CASQUETTE YCF BLEU/BLANCHE**  
YCF BLUE/WHITE CURVED BILL HAT

N° CYCF04-BL

€ 20



**CASQUETTE BASEBALL YCF BLANC/BLEU**  
YCF WHITE/BLUE SNAPBACK HAT

N° CYCF04-WH

€ 20



**SWEAT À CAPUCHE ZIPPÉ YCF (S/ M/ L/ XL/ XXL)**  
YCF ZIP HOODIE (SIZE: S/ M/ L/ XL/ XXL)

N° SWEAT03BL + TAILLE/ SIZE

€ 59



**POLO RACING YCF (S/ M/ L/ XL/ XXL)**  
YCF SHORT SLEEVE POLO (S/ M/ L/ XL/ XXL)

N° POLOYCF01BL+TAILLE/SIZE

€ 35



**T-SHIRT YCF (TAILLE: S/ M/ L/ XL/ XXL)**  
YCF T-SHIRT (SIZE: S/ M/ L/ XL/ XXL)

N° TSYCFWH+TAILLE/SIZE  
N° TSYCFWH+TAILLE/SIZE (XS/ S/ M FEMME/ WOMEN)

€ 19



**T-SHIRT ENFANT YCF (TAILLE: 4 ANS/ 8 ANS)**  
YCF YOUTH T-SHIRT (SIZE: 4 YEARS/ 8 YEARS)

N° TSK02BL-4 (4 YEARS)  
N° TSK02BL-8 (8 YEARS)

€ 19

**NEW  
2023**



**CHAPEAU YCF**  
YCF STRAW HAT

N° STHYCF

€ 29

**NEW  
2023**



**SAC À DOS YCF**  
YCF BACKPACK

N° BACKPACKYCF-GY

€ 49

**NEW  
2023**



**SAC DE TRANSPORT 54X32X32cm**  
TRANSPORT BAG 54X32X32cm

N° BAGYCF-BL

€ 49

# GRAPHICS & PLASTICS



TM

## ACCESSOIRES PLASTIQUES

<b>KITS DÉCO/ GRAPHIC KITS</b>	60
<b>PERSONNALISATION/ CUSTOMIZATION</b>	65
<b>KITS PLASTIQUES/ PLASTIC KITS</b>	66

# RACING KITS DÉCO/ GRAPHIC KITS

3M

⚠ KIT COMPLET POUR GAMME 2007 À 2023  
COMPLETE KIT FOR RANGE 2007 TO 2023



**KIT DÉCO RACING JAUNE/ NOIR pour LITE/ START/ PILOT/ FACTORY/ SM**  
GRAPHICS KIT RACING YELLOW/ BLACK for LITE/ START/ PILOT/ FACTORY/ SM

N° KD-AFT22-BK

€ 79



**KIT DÉCO RACING VERT/ ROUGE pour LITE/ START/ PILOT/ FACTORY/ SM**  
GRAPHICS KIT RACING GREEN/ RED for LITE/ START/ PILOT/ FACTORY/ SM

N° KD-AFT22-GR

€ 79



**KIT DÉCO DE CADRE POUR FACTORY**  
GRAPHIC KIT FOR FACTORY FRAME

N° FGKFP-BK

€ 19



**KIT DÉCO RACING BLEU/ BLANC pour LITE/ START/ PILOT/ FACTORY/ SM**  
GRAPHICS KIT RACING BLUE/ WHITE for LITE/ START/ PILOT/ FACTORY/ SM

N° KD-AFT22-BL

€ 79



**KIT DÉCO RACING ROUGE/ BLEU pour LITE/ START/ PILOT/ FACTORY/ SM**  
GRAPHICS KIT RACING RED/ BLUE for LITE/ START/ PILOT/ FACTORY/ SM

N° KD-AFT22-RD

€ 75



**KIT DÉCO DE CADRE POUR PILOT**  
GRAPHIC KIT FOR PILOT FRAME

N° FGKP-BK

€ 16

**NEW  
2023**



# ORIGINAL YCF® KITS DÉCO/ GRAPHIC KITS

3M®



**KIT DÉCO 50 YCF 2023**  
50 YCF GRAPHIC KIT 2023

N° KD50A2023 (50 SEULEMENT/ ONLY) € 59



**KIT DÉCO LITE 88 2023**  
GRAPHIC KIT LITE 88 2023

N° KD88L2023 € 59



**KIT DÉCO LITE 125 2023**  
GRAPHIC KIT LITE 125 2023

N° KD125L2023 € 59



**KIT DÉCO START W88 2023**  
GRAPHIC KIT START W88E 2023

N° KD88E2023 € 59



**KIT DÉCO 50 YCF 2023**  
50 YCF GRAPHIC KIT 2023

N° KD50E2023 (50 SEULEMENT/ ONLY) € 59



**KIT DÉCO START 88SE 2023**  
GRAPHIC KIT START 88SE 2023

N° KD88SE2023 € 59



**KIT DÉCO START 125 2023**  
GRAPHIC KIT START 125 2023

N° KD1252023 € 59



**KIT DÉCO START 125SE 2023**  
GRAPHIC KIT START 125SE 2023

N° KD125SE2023 € 59



**KIT DÉCO PILOT 125 2023**  
GRAPHIC KIT PILOT 125 2023

Nº KDP1252023

€ 69



**KIT DÉCO PILOT 150E 2023**  
GRAPHIC KIT PILOT 150E 2023

Nº KDP150E2023

€ 69



**KIT DÉCO SM 125 2023**  
GRAPHIC KIT SM 125 2023

Nº KDSM1252023

€ 59



**KIT DÉCO FACTORY SP2 2023**  
GRAPHIC KIT FACTORY SP2 2023

Nº KDSP22023

€ 69



**KIT DÉCO FACTORY SP3 190 2023**  
GRAPHIC KIT FACTORY SP3 190 2023

Nº KDSP31902023

€ 69



**KIT DÉCO SM 155 2023**  
GRAPHIC KIT SM 155 2023

Nº KDSM1552023

€ 69



**KIT DÉCO SM 190 2023**  
GRAPHIC KIT SM 190 2023

Nº KDSM1902023

€ 69



**NEW  
2023**



# ORIGINAL YCF® KITS DÉCO/ GRAPHIC KITS



**KIT DÉCO BIGY FACTORY 190 MX DAYTONA® 2023**  
GRAPHICS KIT BIGY FACTORY 190 MX DAYTONA® 2023

N° KDBIGYFD19023

€ 89



**KIT DÉCO BIGY 125 MX 2023**  
GRAPHICS KIT BIGY 125 MX 2023

N° KDBIGY12523

€ 89



**KIT DÉCO BIGY 150 MX 2023**  
GRAPHICS KIT BIGY 150 MX 2023

N° KDBIGY15023

€ 89



**KIT DÉCO BIGY FACTORY 150 MX-E 2023**  
GRAPHICS KIT BIGY FACTORY 150 MX-E 2023

N° KDBIGYF150E023

€ 89



**KIT DÉCO BIGY SM F190 2023**  
GRAPHICS KIT BIGY FACTORY SM F190 2023

N° KDBIGYSM19023

€ 89





**KIT DÉCO RACING JAUNE/ NOIR pour BIGY**  
 GRAPHICS KIT RACING YELLOW/ BLACK for BIGY

N° KDBIGY-AFT22-BK

€ 99



**KIT DÉCO RACING VERT/ ROUGE pour BIGY**  
 GRAPHICS KIT RACING GREEN/ RED for BIGY

N° KDBIGY-AFT22-GR

€ 99



**KIT DÉCO RACING BLEU/ BLANC pour BIGY**  
 GRAPHICS KIT RACING BLUE/ WHITE for BIGY

N° KDBIGY-AFT22-BL

€ 99



**KIT DÉCO RACING ROUGE/ BLEU pour BIGY**  
 GRAPHICS KIT RACING RED/ BLUE for BIGY

N° KDBIGY-AFT22-RD

€ 99

# PERSONNALISATION CUSTOMIZATION

## 31 968 COMBINAISONS

2 COULEURS DE PLAQUES (PLASTIQUE)  
8 COULEURS DE FONDS DE PLAQUES  
999 CHIFFRES (DESIGN YCF)  
2 COULEURS DE CHIFFRES

YCF ID 1,0 EST LA 1<sup>ÈRE</sup> ÉTAPE DU PROGRAMME DE PERSONNALISATION DE VOTRE MOTO YCF, VOUS POUVEZ MAINTENANT CRÉER VOTRE PLAQUE NUMÉRO ORIGINALE GRÂCE À UN LARGE CHOIX DE DESIGNS GRAPHIQUES ET DE COULEURS.

DISPONIBLE CHEZ VOTRE REVENDEUR.

## 31 968 COMBINATIONS

2 (PLASTIC) PLATE COLORS  
8 BACKGROUND PLATE COLORS  
999 INDIVIDUAL CHARACTERS (YCF DESIGN)  
2 COLORS AVAILABLE

YCF ID 1,0 IS THE FIRST STAGE OF THE CUSTOMIZATION PROCESS FOR YOUR YCF MINI-BIKE, YOU CAN NOW CREATE YOUR OWN ORIGINAL NUMBER PLATE THANKS TO A WIDE CHOICE OF GRAPHIC DESIGNS AND COLOR.

AVAILABLE AT YOUR RETAILER.

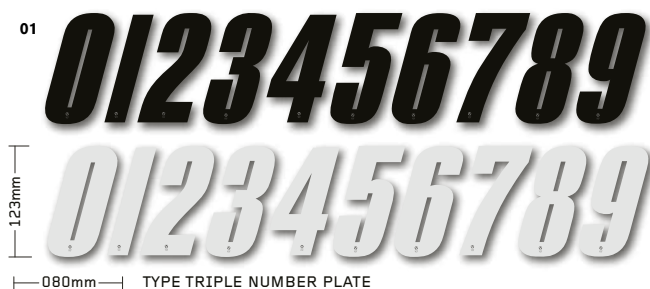

NUMÉRO POUR 3 PAR PLAQUE  
NUMBERS FOR 3 PER PLATE

01 N° NUM.NUMER/8CM (NOIR/ BLACK)  
01 N° NUMW. NUMER/8CM (BLANC/ WHITE) (x3) € 7

NUMÉRO POUR 2 PAR PLAQUE  
NUMBERS FOR 2 PER PLATE

02 N° NUM.NUMER/11CM (NOIR/ BLACK)  
02 N° NUMW.NUMER/11CM (BLANC/ WHITE) (x3) € 8

NUMÉRO POUR 1 PAR PLAQUE  
NUMBERS FOR 1 PER PLATE

03 N° NUM.NUMER/18CM (NOIR/ BLACK)  
03 N° NUMW.NUMER/18CM (BLANC/ WHITE) (x3) € 9



N° STSVYCF-01

€ 9

# KITS PLASTIQUES YCF

## YCF PLASTIC KITS



**PLAQUE AVANT POUR LITE 88 2020-23/ LITE 125/ START 88SE 2020-23/ START 125/ PILOT/ FACTORY/ SM  
NOIRE/ BLEUE/ ROUGE/ VERTE/ JAUNE/ ORANGE/ ROSE/ BLANCHE/ GRISE**

FRONT NUMBER PLATE FOR LITE 88 2020-23/ LITE 125/ START 88SE 2020-23/ START 125/ PILOT/ FACTORY/ SM  
BLACK/ BLUE/ RED/ GREEN/ YELLOW/ ORANGE/ PINK/ WHITE/ GREY

N° YC110-0212-07-COLOR

€ 15



**GARDE BOUE AVANT POUR LITE 125/ START 125/ PILOT/ FACTORY/ SM (2014-2023)/ START 88SE 2021  
NOIR/ BLEU/ ROUGE/ VERT/ JAUNE/ ORANGE/ ROSE/ BLANC/ GRIS**

FRONT FENDER FOR LITE 125/ START 125/ PILOT/ FACTORY/ SM (2014-2023)/ START 88SE 2021  
BLACK/ BLUE/ RED/ GREEN/ YELLOW/ ORANGE/ PINK/ WHITE/ GREY

N° YC110-032-02-COLOR

€ 15



**OUIE RADIATEUR DROITE EN 2 PARTIES POUR PILOT 2018-23/ FACTORY 2017-23/ START 2020-23  
NOIRE/ BLEUE/ ROUGE/ VERTE/ JAUNE/ ORANGE/ BLANCHE/ GRISE**

RIGHT SHROUD 2 PARTS FOR PILOT 2018-23/ FACTORY 2017-23/ START 2020-23  
BLACK/ BLUE/ RED/ GREEN/ YELLOW/ ORANGE/ WHITE/ GREY

N° YC110-14-059-COLOR

€ 19



**OUIE RADIATEUR GAUCHE EN 2 PARTIES POUR PILOT 2018-23/ FACTORY 2017-23/ START 2020-23  
NOIRE/ BLEUE/ ROUGE/ VERTE/ JAUNE/ ORANGE/ BLANCHE/ GRISE**

LEFT SHROUD 2 PARTS FOR PILOT 2018-23/ FACTORY 2017-23/ START 2020-23  
BLACK/ BLUE/ RED/ GREEN/ YELLOW/ ORANGE/ WHITE/ GREY

N° YC110-14-069-COLOR

€ 19



**PLAQUE LATÉRALE DROITE POUR LITE/ START 2017-2023/ PILOT 2007-2015/ FACTORY 2007-2015**  
**NOIRE/ BLEUE/ ROUGE/ VERTE/ JAUNE/ ORANGE/ ROSE/ BLANCHE**

RIGHT NUMBER PLATE FOR LITE/ START 2017-2023/ PILOT 2007-2015/ FACTORY 2007-2015  
 BLACK/ BLUE/ RED/ GREEN/ YELLOW/ ORANGE/ PINK/ WHITE

Nº YC110-14-022-COLOR

€ 12



**PLAQUE LATÉRALE GAUCHE POUR LITE/ START 2017-2023/ PILOT 2007-2015/ FACTORY 2007-2015**  
**NOIRE/ BLEUE/ ROUGE/ VERTE/ JAUNE/ ORANGE/ ROSE/ BLANCHE**

LEFT NUMBER PLATE FOR LITE/ START 2017-2023/ PILOT 2007-2015/ FACTORY 2007-2015  
 BLACK/ BLUE/ RED/ GREEN/ YELLOW/ ORANGE/ PINK/ WHITE

Nº YC110-14-042-COLOR

€ 12



**PLAQUE LATÉRALE DROITE POUR PILOT 2016-23/ FACTORY 2016-23**  
**NOIRE/ BLEUE/ ROUGE/ VERTE/ JAUNE/ ORANGE/ BLANCHE/ GRISE**

RIGHT NUMBER PLATE FOR PILOT 2016-23/ FACTORY 2016-23  
 BLACK/ BLUE/ RED/ GREEN/ YELLOW/ ORANGE/ WHITE/ GREY

Nº YC110-14-028-COLOR

€ 15



**PLAQUE LATÉRALE GAUCHE POUR PILOT 2016-23/ FACTORY 2016-23**  
**NOIRE/ BLEUE/ ROUGE/ VERTE/ JAUNE/ ORANGE/ BLANCHE/ GRISE**

LEFT NUMBER PLATE FOR PILOT 2016-23/ FACTORY 2016-23  
 BLACK/ BLUE/ RED/ GREEN/ YELLOW/ ORANGE/ WHITE/ GREY

Nº YC110-14-048-COLOR

€ 15





**GARDE BOUE ARRIÈRE POUR LITE/ START 2007-2023/ PILOT 2007-2015/ FACTORY 2007-2015**  
**NOIR/ BLEU/ ROUGE/ VERT/ JAUNE/ ORANGE/ ROSE/ BLANC**

REAR FENDER FOR LITE/ START 2007-2023/ PILOT 2007-2015/ FACTORY 2007-2015  
 BLACK/ BLUE/ RED/ GREEN/ YELLOW/ ORANGE/ PINK/ WHITE

Nº YC110-14-012-COLOR

€ 12



**PAIRE DE PROTECTIONS FOURCHE (ADAPTABLE SUR TOUTES LES FOURCHES)**  
**NOIRES/ BLEUES/ ROUGES/ VERTES/ JAUNES/ ORANGES/ BLANCHES**

PAIR OF FORK GUARD (WITH SLOTTED HOLE ADAPTABLE TO ALL FORKS)  
 BLACK/ BLUE/ RED/ GREEN/ YELLOW/ ORANGE/ WHITE

Nº PFYCF12-COLOR (735mm)  
 Nº YC110-0418-01WH (BLANC/ WHITE - 660mm)  
 Nº YC110-0418-01BK (NOIR/ BLACK - 660mm)

€ 25  
 € 30  
 € 30



**GARDE BOUE ARRIÈRE POUR PILOT 2016-23/ FACTORY 2016-23**  
**NOIR/ BLEU/ ROUGE/ VERT/ JAUNE/ ORANGE/ BLANC/ GRIS**

REAR FENDER FOR PILOT 2016-23/ FACTORY 2016-23  
 BLACK/ BLUE/ RED/ GREEN/ YELLOW/ ORANGE/ WHITE/ GREY

Nº YC110-14-018-COLOR

€ 15



**FOR 50 ONLY**



**PAIRE DE PROTECTIONS FOURCHE POUR YCF 50 BLEU/ ROUGE/ VERT/ JAUNE/ ORANGE/ BLANC**  
 FORK GUARD FOR YCF 50 BLUE/ RED/ GREEN/ YELLOW/ ORANGE/ WHITE

Nº YC50-0418-COLOR

€ 19



**GARDE BOUE AVANT YCF NOIR/ BLEU/ BLEU YCF/ ROUGE/ VERT/ JAUNE/ ORANGE/ BLANC/ GRIS**  
 YCF FRONT FENDER BLACK/ BLUE/ YCF BLUE/ RED/ GREEN/ YELLOW/ ORANGE/ WHITE/ GREY

N° YC110-032-10-COLOR

€ 19



**GARDE BOUE ARRIÈRE YCF NOIR/ ROUGE/ BLANC/ VERT/ JAUNE/ ORANGE/ BLEU/ GRIS**  
 YCF REAR FENDER BLACK/ RED/ WHITE/ GREEN/ YELLOW/ ORANGE/ BLUE/ GREY

N° YC110-14-019-COLOR

€ 19



**OUIE RADIATEUR YCF DROITE NOIRE/ BLEUE/ ROUGE/ VERTE/ JAUNE/ ORANGE/ BLANCHE/ GRISE**  
 YCF RIGHT SHROUD BLACK/ BLUE/ RED/ GREEN/ YELLOW/ ORANGE/ WHITE/ GREY

N° YC110-1406-COLOR

€ 19



**OUIE RADIATEUR YCF GAUCHE NOIRE/ BLEUE/ ROUGE/ VERTE/ JAUNE/ ORANGE/ BLANCHE/ GRISE**  
 YCF LEFT SHROUD BLACK/ BLUE/ RED/ GREEN/ YELLOW/ ORANGE/ WHITE/ GREY

N° YC110-1407-COLOR

€ 19



**PLAQUE AVANT YCF NOIR/ BLEU/ BLEU YCF/ ROUGE/ VERT/ JAUNE/ ORANGE/ BLANC/ GRIS**  
YCF FRONT NUMBER PLATE BLACK/ BLUE/ YCF BLUE/ RED/ GREEN/ YELLOW/ ORANGE/ WHITE/ GREY

Nº YC110-0212-09-COLOR

€ 19



**PLAQUE LATÉRALE YCF DROITE NOIR/ BLEU/ ROUGE/ VERT/ JAUNE/ ORANGE/ BLANC/ GRIS**  
YCF RIGHT NUMBER PLATE BLACK/ BLUE/ RED/ GREEN/ YELLOW/ ORANGE/ WHITE/ GREY

Nº YC110-14-029-COLOR

€ 19



**PLAQUE LATÉRALE YCF GAUCHE NOIR/ BLEU/ ROUGE/ VERT/ JAUNE/ ORANGE/ BLANC/ GRIS**  
YCF LEFT NUMBER PLATE BLACK/ BLUE/ RED/ GREEN/ YELLOW/ ORANGE/ WHITE/ GREY

Nº YC110-14-049-COLOR

€ 19





FOR 50 ONLY



**KIT PLASTIQUE YCF 50 NOIR/ BLEU/ ROUGE/ VERT/ JAUNE/ ORANGE/ ROSE/ BLANC**  
YCF 50 PLASTIC KIT BLACK/ BLUE/ RED/ GREEN/ YELLOW/ ORANGE/ PINK/ WHITE

N° KPYCF50-02-COLOR € 69

**GARDE BOUE AVANT POUR YCF 50, LITE 88 2020-22, START 88SE 2022, SM 2022 NOIR/ BLEU/ ROUGE/ VERT/ JAUNE/ ORANGE/ ROSE/ BLANC**  
FRONT FENDER FOR YCF 50 AND LITE 88 2020 BLACK/ BLUE/ RED/ GREEN/ YELLOW/ ORANGE/ PINK/ WHITE

01 N° YC50-031-01-COLOR € 15  
02 N° YC50-0212-03-COLOR PLAQUE AVANT € 17

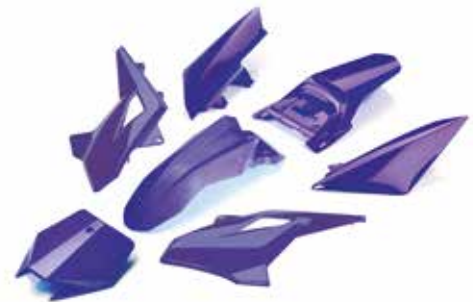

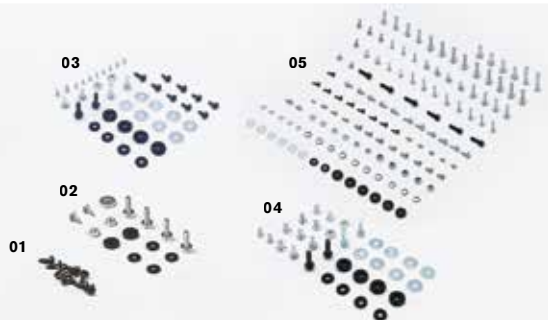

**KIT VIS POUR FIXER LES PLASTIQUES SUR LA SELLE**  
BOLT KIT FOR FIXING THE PLASTICS TO THE SEAT

01 N° KVP € 2

**KIT VISSERIE POUR KIT PLASTIQUE (2+2 POUR RÉSERVOIR + 2 POUR SELLE SUR CADRE)**  
BOLT KIT FOR PLASTIC KIT (2+2 FOR FUEL TANK + 2 FOR SEAT ON FRAME)

02 N° KVP-2 € 3

**KIT VISSERIE POUR PLASTIQUE START/ PILOT/ FACTORY**  
BOLT KIT FOR PLASTIC KIT START/ PILOT/ FACTORY

03 N° KVP-3 € 6

**KIT VISSERIE POUR PLASTIQUE BIGY**  
BOLT KIT FOR PLASTIC KIT BIGY

04 N° KVP-4 € 6

**KIT VIS COMPLET YCF**  
COMPLETE YCF BOLT KIT

05 N° KVP-5 € 39



**PROTÈGE DISQUE AVANT NOIR/ BLEU/ ROUGE/ VERT/ JAUNE/ ORANGE/ BLANC**  
FRONT BRAKE PROTECTION BLACK/ BLUE/ RED/ GREEN/ YELLOW/ ORANGE/ WHITE

N° YC110-0627-COLOR € 35



**PASSE DURITE FREIN AVANT CNC NOIR/ BLEU/ ROUGE/ VERT/ ORANGE**  
OIL STEEL LINE RETAINER BLACK/ BLUE/ RED/ GREEN/ ORANGE

N° YC110-0403-06-COLOR € 19



**PASSE DURITE YCF**  
YCF BRAKE HOSE

01 N° YC110-0403-05 € 5



**KIT RONDELLE CNC POUR RÉSERVOIR ET KIT PLASTIQUE, VENDU AVEC LES VIS BTR (2XM5/ 2XM6/ 1XM8)**  
NOIR/ BLEU/ ROUGE/ VERT/ ORANGE

CNC WASHER AND BTR SCREW FOR TANK AND PLASTIC KIT (2XM5/ 2XM6/ 1XM8)  
BLACK/ BLUE/ RED/ GREEN/ ORANGE

N° KRV-COLOR € 19



**KIT COMPLET PHARES POUR START/ LITE/ FACTORY SP1 & SP2/ BIGY 125 & 150**  
LIGHT KIT FOR START/ LITE/ FACTORY SP1 & SP2/ BIGY 125 & 150

N° KL1E pour moto avec démarreur électrique/ for electric start bike € 119  
N° KL1 € 159  
01 N° YC110-1525-02 Bavette arrière/ tail light mud guard € 29



**PLAQUE PHARE AVANT YCF NOIRE/ BLANCHE**  
YCF HEADLIGHT BLACK/ WHITE

N° YC110-1523-02 - COLOR € 59

# MOTORCYCLE PARTS

## PIÈCES MOTO

<b>GUIDONS/ HANDLEBARS</b>	74
<b>POIGNÉES/ LEVERS</b>	76
<b>FOURCHES/ FORKS</b>	78
<b>CADRES/ FRAMES</b>	81
<b>SELLES/ SEATS</b>	82
<b>RÉSERVOIRS/ FUEL TANKS</b>	83
<b>FREINS/ BRAKES</b>	84
<b>BRAS OSCILLANTS/ SWING ARMS</b>	92
<b>AMORTISSEURS/ SHOCK ABSORBERS</b>	94
<b>ROUES/ WHEELS</b>	95
<b>JANTES &amp; MOYEUX/ RIMS &amp; HUBS</b>	95
<b>PNEUS/ TIRES</b>	102
<b>REPOSE-PIEDS &amp; SABOTS/ FOOT PEGS &amp; SKID PLATES</b>	104
<b>SÉLECTEURS/ SHIFT LEVERS</b>	105
<b>KITS CHÂINES/ SPROCKET KITS</b>	106
<b>OUTILS/ TOOLS</b>	108
<b>ENGI®/ ENGI®</b>	110
<b>PIÈCES SPÉCIALES SUPERMOTARD/ SUPERMOTO FACTORY SPECIAL PARTS</b>	112



# GUIDONS HANDLE BARS



**MOUSSE GUIDON SANS BARRE**  
NOIRE/ BLEUE/ ROUGE/ VERTE/ JAUNE/ ORANGE/ ROSE/ BLANCHE  
HANDLEBAR PAD WITHOUT CROSSBAR  
BLACK/ BLUE/ RED/ GREEN/ YELLOW/ ORANGE/ PINK/ WHITE

N° YC110-01046-COLOR

€ 12



**MOUSSE GUIDON CAOUTCHOUC 3D**  
HANDLEBAR PAD WITH RUBBER COVER 3D

N° YC110-0133-01BK

€ 12



FOR 50 ONLY

**MOUSSE GUIDON YCF 50 SANS BARRE**  
NOIRE/ BLEUE/ ROUGE/ VERTE/ JAUNE/ ORANGE/ ROSE/ BLANCHE  
HANDLEBAR PAD YCF 50 WITHOUT CROSSBAR  
BLACK/ BLUE/ RED/ GREEN/ YELLOW/ ORANGE/ PINK/ WHITE

N° YC50-0129-COLOR

€ 8



**MOUSSE GUIDON NOIRE/ BLEUE/ ROUGE/ VERTE/ JAUNE/ ORANGE/ ROSE/ BLANCHE**  
HANDLEBAR PAD BLACK/ BLUE/ RED/ GREEN/ YELLOW/ ORANGE/ PINK/ WHITE

N° YC110-0132-COLOR

€ 10



**PAIRE DE PROTÈGES MAINS**  
HANDGUARD

N° YC110-14-070BK (NOIRE/ BLACK)  
N° YC110-14-070WH (BLANCHE/ WHITE)

€ 25



**PAIRE DE PROTÈGES MAINS ENDURO/SUPERMOTO**  
(FIXATION POUR GUIDON ACIER/ALU Ø 22,2 ET 28,6)  
ENDURO/SUPERMOTO HANDGUARDS  
(FIXING KITS FOR STEEL/ALU Ø 22,2 AND 28,6)

N° YC110-14-071BK (NOIRE/ BLACK)  
N° YC110-14-071WH (BLANCHE/ WHITE)

€ 69



**PROTÈGE LEVIER TYPE MOTOGP**  
MOTOGP STYLE LEVER PROTECTION

N° YC110-14-072BK

€ 39



**GUIDON ALUMINIUM (MOUSSE COMPRISE)  
NOIR/ BLEU/ ROUGE/ VERT/ ORANGE**

ALUMINUM HANDLEBAR (BAR PAD INCLUDED)  
BLACK/ BLUE/ RED/ GREEN/ ORANGE

N° GA-COLOR

€ 45



**GUIDON ALUMINIUM SANS BARRE (POUR YCF 50) NOIR/ BLEU/ ROUGE/ VERT/  
ORANGE (MOUSSE COMPRISE)**

ALUMINUM HANDLEBAR WITHOUT CROSSBAR (FOR YCF 50) BLACK/ BLUE/ RED/ GREEN/  
ORANGE (BAR PAD INCLUDED)

01 N° GASB50-COLOR

€ 39

**GUIDON ALUMINIUM SANS BARRE BLEU/ NOIR/ ROUGE/ ORANGE/ VERT  
(MOUSSE COMPRISE)**

ALUMINUM HANDLEBAR WITHOUT CROSSBAR BLUE/ BLACK/ RED/ ORANGE/  
GREEN (BAR PAD INCLUDED)

02 N° GASB-COLOR

€ 59



**GUIDON MID SIZE ALUMINIUM (MOUSSE COMPRISE)  
NOIR/ BLEU/ ROUGE/ VERT/ ORANGE**

ALUMINUM CROSS BAR (BAR PAD INCLUDED)  
BLACK/ BLUE/ RED/ GREEN/ ORANGE

N° GALOW-COLOR

€ 45

N° GALOW-03BK (BIGY)

€ 49

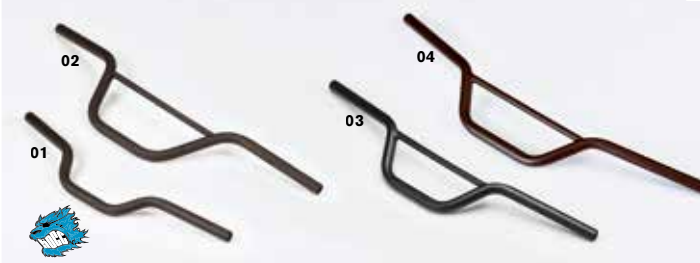

**GUIDON ACIER (POUR YCF 50)**

STEEL HANDLEBAR (FOR YCF 50)

**GUIDON CHROMOLLY 22,2mm**

CHROMOLLY HANDLEBAR 22,2mm

01 N° YC50-0101-02 (YCF 50)

€ 15

02 N° YC110-0101-01 (LITE/ START/ PILOT)

03 N° YC110-0101-12 (BAS/ LOW: 665mm)

04 N° YC110-0101-1601-BK (BIGY: 780mm)

€ 19



**GUIDON ALUMINIUM RENFORCÉ 28.6 mm**

ALUMINUM HANDLEBAR 28.6 mm

N° GA-02BK (FACTORY 760mm)

€ 79

N° GALOW-04BK (BIGY 780mm)

€ 79



# POIGNÉES HANDLES



FOR 50 ONLY



01

02

**FACTORY**  
SPECIAL PARTS  
YCF RACING

**LEVIER DE FREIN AVANT OU ARRIÈRE PLIABLE POUR YCF 50 2020-23  
NOIR/ BLEU/ ROUGE/ VERT/ ORANGE**

FOLDABLE FRONT OR REAR BRAKE LEVER FOR YCF 50 2020-23  
BLACK/ BLUE/ RED/ GREEN/ ORANGE

01 № LFG50-1-COLOR (ARRIÈRE/ REAR)  
02 № LFD50-1-COLOR (AVANT/ FRONT)

€ 35



**FACTORY**  
SPECIAL PARTS  
YCF RACING



**LEVIER D'EMBRAYAGE AVEC COCOTTE CNC NOIR/ BLEU/ ROUGE/ VERT  
CLUTCH LEVER WITH CNC BRACKET BLACK/ BLUE/ RED/ GREEN**

№ YC110-0103-06-COLOR

€ 99

**FACTORY**  
SPECIAL PARTS  
YCF RACING



01

02

**LEVIER DE FREIN OU D'EMBRAYAGE PLIABLE NOIR/ BLEU/ ROUGE/ VERT/ ORANGE  
VENDU AVEC LA COCOTTE**

FOLDABLE BRAKE OR CLUTCH LEVER BLACK/ BLUE/ RED/ GREEN/ ORANGE  
SOLD WITH BRACKET

01 № LFP21-COLOR (FREIN/BRAKE)  
02 № LEP21-COLOR (EMBRAYAGE/ CLUTCH)

€ 35

€ 39



01

02

**LEVIER FREIN OU EMBRAYAGE REPLIABLE  
VENDU AVEC LA COCOTTE**

FOLDABLE BRAKE OR CLUTCH LEVER  
SOLD WITH BRACKET

01 № LEPLIABLE (EMBRAYAGE/ CLUTCH)  
02 № LFPLIABLE (FREIN/ BRAKE)

€ 25

€ 25



01

03

02

**POIGNÉE DE GAZ À TIRAGE RAPIDE YCF (VENDU AVEC  
LES 2 POIGNÉES)**

YCF QUICK-ACTION THROTTLE TUBE ( INCLUDE GRIP )

01 № YC110-0138-03

€ 25

**POIGNÉE DE GAZ AVEC RÉGLAGE (VIS DE BRIDAGE)**

THROTTLE TUBE WITH ADJUSTMENT SCREW ( POWER  
CONTROL )

02 № YC110-0138-04 (Vendu avec les 2 poignées)

€ 25

**VIS M5X50 POUR RÉGLAGE DE LA POIGNÉE DE GAZ**

SCREW FOR THROTTLE ADJUSTMENT, SIZE M5X50

03 № YC110-01022-06

€ 3





**LEVIER FREIN PLIABLE**  
FOLDABLE BRAKE LEVER

N° YC110-0517-01

€ 15



**LEVIER D'EMBRAYAGE + COCOTTE AVEC MOLETTE RAPIDE (2020-23)**

CLUTCH LEVER + BRACKET WITH FAST WRENCH ADJUSTER (2020-23)

N° YC110-0135-02

€ 19



**EMBOUIT PLASTIQUE DE GUIDON**  
BAR END CAPS

N° YC110-0153-01

€ 2



**LEVIER FREIN COMPLET AVEC COCOTTE POUR YCF 50**  
BRAKE LEVER COMPLETE WITH BRACKET FOR YCF 50

N° YC50-0501 (AVANT/ FRONT) (YCF 50 2012-19)  
N° YC50-01031 (ARRIÈRE/ REAR) (YCF 50 2012-19)

€ 10



**COCOTTE D'EMBRAYAGE**  
CLUTCH BRACKET

01 N° YC110-0134-04 (2020-23)  
02 N° YC110-0126-01 (YCF 2005-17)

€ 15  
€ 12

**CAOUTCHOUC DE LEVIER FREIN & EMBRAYAGE**  
RUBBER BRAKE & CLUTCH LEVERS

09 N° YC110-0502-01 (FREIN/ BRAKE)  
10 N° YC110-0103-10 (EMBRAYAGE/ CLUTCH)

€ 3

**LEVIERS FREIN & EMBRAYAGE**  
BRAKE & CLUTCH LEVERS

04 N° YC110-0103-07 (EMBR./ CLUTCH) (PILOT/ SM/ FACTORY/ BIGY 2020-23) € 9  
05 N° YC110-0501-014 (FREIN/ BRAKE) (2005-17) € 8  
06 N° YC110-0103-03 (EMBR./ CLUTCH) (2005-17) € 8  
07 N° YC50-0503-05 (FREIN AVANT/ FRONT BRAKE) (YCF 50 2020-23) € 8  
08 N° YC50-0503-06 (FREIN ARRIÈRE/ REAR BRAKE) (YCF 50 2020-23) € 8

**LEVIER FREIN RÉGLABLE POUR KIT FREIN 4 PISTONS**  
ADJUSTABLE BRAKE LEVER FOR 4 PISTONS BRAKE KIT

03 N° YC110-0501-012

€ 9



**POIGNÉES CAOUTCHOUC YCF (X2)**  
NOIRE/ BLEUE/ ROUGE/ VERTE/ JAUNE/ ORANGE/ ROSE/ BLANCHE/ GRISE

YCF RUBBER GRIPS (X2) BLACK/ BLUE/ RED/ GREEN/ YELLOW/ ORANGE/ PINK/ WHITE/ GREY

N° PPC011-COLOR

€ 12



**DONUTS (X2) NOIR/ ROUGE/ VERT/ JAUNE/ ORANGE**  
GRIP DONUTS (X2) BLACK/ RED/ GREEN/ YELLOW/ ORANGE

N° DONUTZ-02-COLOR

€ 5



**CÂBLE EMBRAYAGE**  
CLUTCH CABLE

01 N° YC110-0107 L=900mm A+B=93mm (SM125 2021-23/ SM190 2021) € 11  
01 N° YC110-0108 L=900mm A+B=65mm (SP1/ SM150) € 11  
01 N° YC110-0109-21 L=1000mm A+B=105mm (PILOT 150/ BIGY MX150)  
01 N° YC110-0109-22 L=1000mm A+B=93mm (SP3 190/ BIGY 190)  
02 N° YC110-0109-20 L=950mm A+B=75mm (LITE 125/ START 125/ BIGY 125MX)  
02 N° YC110-0109-23 L=920mm A+B=75mm (SP2) € 12



**CÂBLE DE GAZ**  
THROTTLE CABLE

01 N° CGCOUDEE (CURVED OUTLET/ COUDÉ) € 12  
02 N° YC110-0106 (ALL RANGE EXCEPT YCF50) € 12  
02 N° YC50-0106-14 (FOR 50 ONLY) € 11  
02 N° YC110-0106-12 (BIGY) € 13  
02 N° YC110-0106-17 (LITE/START/PILOT/SM125/SP2 2021-23 NIBBI CARBURETOR)  
02 N° YC110-0106-18 (BIGY 125/150 2021-23 NIBBI CARBURETOR) € 12

# FOURCHES FORKS



## KIT RÉFÉCTION FOURCHE TAILLE 33/46/11 : 1 JOINT SPY/ 1 CACHE POUSSIÈRE/ 1 BAGUE INF/ 1 BAGUE SUP

FORK REPAIR KIT SIZE 33/46/11 INCLUDING: 1 FORK OIL SEAL/ 1 DUST COVER/ 1 LOWER RING/ 1 UPPER RING

N° YC110-0470

€ 19

## JOINT SPY FOURCHE

FORK OIL SEAL

01 N° YC50-0415 (POUR/ FOR 50 - 25X25X10)

€ 8

01 N° YC110-0440 (33\*46\*11) START/ PILOT/ FACTORY/ BIGY

€ 9



## TÉ FOURCHE COMPLET 170MM SP3 48/48 (AVEC PONTETS GUIDON 28,6mm) (NOIR/ BLEU/ ROUGE/ VERT/ ORANGE)

TRIPLE CLAMP SET 48/48 170MM SP3  
(WITH BAR MOUNTS 28,6mm)  
(BLACK/ BLUE/ RED/ GREEN/ ORANGE)

01 N° YC110-0225-05-COLOR

€ 199



## JEU TUBE FOURCHE RÉGLABLE

ADJUSTABLE FORK

N° YC110-0400-10 (735mm)

€ 349

N° YC110-0400-47 (775mm)

€ 359

N° YC110-0400-35 (800mm)

€ 359



## JEU TUBE FOURCHE UPSD NON RÉGLABLE

UPSD FORK

N° YC110-0400-43 (600mm)

€ 209

N° YC110-0400-41 (660mm)

€ 209

N° YC110-0400-40 (735mm)

€ 209

N° YC110-0400-33 (785mm)

€ 239







**TÉ FOURCHE COMPLET 160mm 45/48 OU 48/48 (NOIR/ BLEU/ ROUGE/ VERT/ ORANGE)**  
TRIPLE CLAMP SET 160mm 45/48 OR 48/48 (BLACK/ BLUE/ RED/ GREEN/ ORANGE)

N° YC110-02-053-COLOR (45/48)  
N° YC110-02-049-COLOR (48/48)

€ 159  
€ 199



**JEU DE PONTETS GUIDON YCF 2012-2019**  
BAR MOUNTS FOR YCF 2012-2019

01 N° YC110-0203-05 (LITE/ START/ PILOT/ SM/ BIGY MX) Ø 22,2 € 39  
02 N° YC110-0203-15 (SP3 2016-19/ BIGY 190 DAYTONA 2017-19) Ø 28,6 € 59  
03 N° YC110-0222-01 CALE POUR PONTET GUIDON ÉPAISSEUR 20mm (VENDU PAR PAIRE) (NON RÉGLABLE/ NOT ADJUSTABLE) € 12  
03 N° YC110-0222-02 CALE POUR PONTET GUIDON ÉPAISSEUR 20mm (VENDU PAR PAIRE) (RÉGLABLE/ ADJUSTABLE) € 20



**JEU DE PONTETS GUIDON YCF 2020-23**  
BAR MOUNT FOR YCF 2020-23

04 N° YC110-0203-038 (FACTORY SP3/ BIGY 190 DAYTONA) Ø 28,6  
05 N° YC110-0203-035 (50/ LITE/ START/ PILOT/ SP2/ BIGY MX) Ø 22,2  
06 N° YC110-0222-03 CALE POUR PONTETS GUIDON (VENDU PAR PAIRE)

€ 69  
€ 49  
€ 12



**ÉCROU POUR COLONNE DE DIRECTION**  
STREERING STEM NUT

01 N° YC110-02-09 (NOTCHED/ CRANTÉ)  
02 N° YC110-02-11 (SUPÉRIEUR/ UPPER)

€ 6



**JOINT POUR COLONNE DE DIRECTION ADAPTABLE**  
**SUR START/ PILOT/ FACTORY/ SM/ BIGY**

SEAL FOR STEERING STEM ADAPTABLE ON START/ PILOT/  
FACTORY/ SM/ BIGY

N° YC110-02-20

€ 6



**FACTORY**  
SPECIAL PARTS  
YCF RACING

**JEU DE ROULEMENT COLONNE DIRECTION**  
TAPER ROLLER BEARING FOR STEERING STEM

N° KRDIRIRECTION41-2, YCF50 2012-19 – START 88 2008-19 – LITE88/125 2016-19  
(INFÉRIEUR Ø EXT 41 - INT 24mm/ SUPÉRIEUR Ø EXT 41 - INT 22,5mm)  
N° KRDIRIRECTION46, ALL START 125 – PILOT – FACTORY – BIGY and 50A-E 2020-23 – START 88SE 2020-23  
LITE 88-125 2020-23 (INFÉRIEUR Ø EXT 46 - INT 23,5mm/ SUPÉRIEUR Ø EXT 46 - INT 22mm)

€ 29

€ 39



**ÉCROU POUR COLONNE DE DIRECTION NOIR/ BLEU/ ROUGE/ VERT/ ORANGE**  
STREERING STEM NUT BLACK/ BLUE/ RED/ GREEN/ ORANGE

N° ECD-COLOR

€ 12



# CADRES FRAMES



## BÉQUILLE STAND

01 N° YC110-0904-01 (RÉGLABLE 250mm to 350mm) € 19  
01 N° YC110-0904-05 (BIGY)

## RESSORT DE BÉQUILLE STAND'S SPRING

02 N° YC110-19-01 € 3

## VIS ET ÉCROU BÉQUILLE STAND SCREW & NUT

03 N° GB6170-M10-G (ÉCROU/ NUT) € 2  
04 N° FB02-M10x1,5x30I (VIS/ SCREW)

## KIT VIS RENFORCÉE POUR MOTEUR ENGINE REINFORCED SCREW SET

05 N° KITVIS8 (Ø 8) € 9  
05 N° KITVIS10 (Ø 10)

## PATTE DE CADRE FRAME STEEL PADS

N° YC110-16-061BK (START F125) € 15  
N° YC110-16-067BK (PILOT 2013) € 15  
N° YC110-1622-02BK (PILOT 2014-2023) € 19  
N° YC110-1622-03 (BIGY) € 49

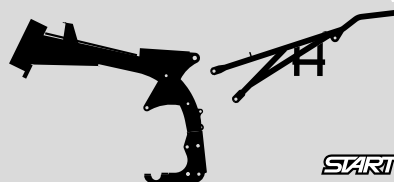

## CADRE BLANC RENFORCÉ 88 POUR BRAS MONO (BOUCLE ARRIÈRE INCLUSE)

88 REINFORCED WHITE FRAME FOR MONO SWING ARM  
(REAR SUBFRAME INCLUDED)

N° YC88-161-0301-BK (START SE88) € 149



## BOUCLE ARRIÈRE 88 88 REAR SUBFRAME

N° YC88-16-020 (START F88S) € 59  
N° YC88-16-022-BK (START F88SE)



## CADRE RENFORCÉ LITE POUR BRAS CANTILEVER (BOUCLE ARRIÈRE INCLUSE)

LITE YCF REINFORCED FRAME FOR CANTILEVER SWING  
ARM (REAR SUBFRAME INCLUDED)

N° YC110-161-0301-BK (LITE88) € 179  
N° YC110-161-0401-BK (LITE 125/ 150) € 179



## BOUCLE ARRIÈRE LITE LITE REAR SUBFRAME

N° YC110-1614-23-BK (LITE F88) € 59  
N° YC110-1614-24-BK (LITE F125/ F150) € 59



## CADRE START BLANC POUR BRAS MONO ET AMORTISSEUR 270mm (BOUCLE AR. INCLUSE)

START WHITE FRAME FOR MONO SWING ARM AND SHOCK  
ABSORBER 270mm (REAR SUBFRAME INCL.)

N° YC110-166-0201-BK (START 125S) € 169



## BOUCLE ARRIÈRE START 125 START 125 REAR SUBFRAME PART

N° YC110-16-070BK € 59  
N° YC110-1614-28-BK (START 125SE) € 59



## CADRE COMPLET PILOT 125 & 150 2018-23 (AXE BRAS Ø 15) (BOUCLE ARRIÈRE INCLUSE)

2018-23 PILOT 125 & 150 COMPLETE FRAME (ARM AXLE Ø 15)  
(REAR SUBFRAME INCLUDED)

N° YC110-1621-0301-BK (NOIR/BLACK) (axle 15) € 299

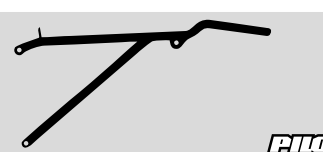

## BOUCLE ARRIÈRE PILOT PILOT REAR SUBFRAME

N° YC110-1614-26-BK (2016-23) € 79



## CADRE YCF 2019-2023 FACTORY (BOUCLE AR. INCLUSE) 2019-23 FACTORY YCF FRAME (REAR SUBFRAME INCL.)

N° YC110-1621-0801-BK (CADRE 22°) € 329



## BOUCLE ARRIÈRE FACTORY FACTORY REAR SUBFRAME

N° YC110-1614-15-BK (2016-23 ACIER/ STEEL) € 79  
N° YC110-1614-18 (2016-23 ALUMINIUM) € 99



## CADRE YCF 2018-23 BIGY (AXE BRAS Ø 15) (BOUCLE ARRIÈRE INCLUSE)

2018-23 BIGY YCF FRAME (ARM AXLE Ø 15) (REAR SUBFRAME  
INCLUDED)

N° YC110-1621-0201-BK (COMPLET) € 349



## BOUCLE ARRIÈRE BIGY BIGY REAR SUBFRAME

N° YC110-1614-08-BK (ACIER/ STEEL) € 99  
N° YC110-1614-09-BK (190ZE/ F150E 2022-23) € 99

# SELLES SEATS

**FACTORY**  
SPECIAL PARTS  
YCF RACING



**SELLE COMPLÈTE ANTI DÉRAPANTE RENFORCÉE BLEUE/ ROUGE/ VERTE/ JAUNE/ ORANGE**  
COMPLETE NON-SLIP REINFORCED SEAT BLUE/ RED/ GREEN/ YELLOW/ ORANGE

N° YC110-1401-12-COLOR (BIGY)

€ 89

**FACTORY**  
SPECIAL PARTS  
YCF RACING



**SELLE COMPLÈTE ANTI DÉRAPANTE RENFORCÉE BLEUE/ ROUGE/ VERTE/ JAUNE/ ORANGE**  
COMPLETE NON-SLIP REINFORCED SEAT BLUE/ RED/ GREEN/ YELLOW/ ORANGE

N° YC110-1401-08-COLOR ( LITE 2016-23, START 2009-23, PILOT 125 2013-14)  
N° YC110-1401-07-COLOR (PILOT 125 2015-23, PILOT 150, FACTORY, SM 150)

€ 65

€ 79



**SELLE YCF POUR BIGY**  
YCF SEAT FOR BIGY

N° YC110-1401-11

€ 79

**FACTORY**  
SPECIAL PARTS  
YCF RACING



**SELLE YCF LONGUE PILOT 125 2015-23/ PILOT 150 2013-23/ FACTORY 2012-23/ SM 150 2013-23/ SM 190 2023**  
YCF LONG SEAT PILOT 125 2015-23/ PILOT 150 2013-23/ FACTORY 2012-23/ SM 150 2013-23/ SM 190 2023

N° YC110-1401-17

€ 69

**FOR 50 ONLY**



01

02



**SELLE YCF 50**  
YCF 50 SEAT

01 N° YC50-1401-05

€ 39

02 N° YC50-1401-03 (HAUTE/ HIGH + 4 cm)

€ 39



**SELLE LITE 2016-23/ START 2009-23/ PILOT 125 2013-14**  
SEAT LITE 2016-23/ START 2009-23/ PILOT 125 2013-14

N° YC110-1401-10

€ 49



**SELLE BASSE YCF POUR LITE 2016-23/ START 2009-23/ PILOT 125 2013-14**

YCF LOW SEAT FOR LITE 2016-23/ START 2009-23/ PILOT 125 2013-14

N° YC110-14013

€ 49



**FOR 50 ONLY**



**SELLE COMPLÈTE ANTI DÉRAPANTE RENFORCÉE BLEUE/ ROUGE/ VERTE/ JAUNE/ ORANGE**

COMPLETE NON-SLIP REINFORCED SEAT BLUE/ RED/ GREEN/ YELLOW/ ORANGE

N° YC50-1401-02-COLOR (50 SEULEMENT/ ONLY)

€ 59

# RÉSERVOIRS FUEL TANKS



**RÉSERVOIR ET COUVRE RÉSERVOIR YCF POUR BIGY**  
YCF FUEL TANK AND TANK COVER FOR BIGY

01 N° YC110-0701-04  
02 N° YC110-0719-01

€ 59  
€ 15



**RÉSERVOIR YCF (ADAPTABLE SUR TOUTES LES ANCIENNES YCF ET SUR LES MINIS AVEC RÉSERVOIR TYPE CRF 50)**

YCF FUEL TANK (CAN BE ADAPTED TO ALL PREVIOUS YCF AND TO MINI-BIKES WITH A TYPE CRF 50 FUEL TANK)

N° YC110-0701-01

€ 45



**RÉSERVOIR POUR YCF 50**  
FUEL TANK FOR YCF 50

N° YC50-07012

€ 39



**BOUCHON RÉSERVOIR ALUMINIUM YCF NOIR/ BLEU ROUGE/ VERT/ ORANGE/**

YCF ALUMINUM GAS CAP BLACK/ BLUE / RED/ GREEN ORANGE

N° BOUCHONALU-COLOR

€ 35



**VALVE PRISE AIR NOIRE/ BLEUE/ ROUGE/ VERTE/ ORANGE**

FUEL VENT VALVE BLACK/ BLUE/ RED/ GREEN/ ORANGE

N° YC125-0704-COLOR

€ 9



**DURITE ESSENCE BLEU/ ROUGE/ VERT/ JAUNE/ ORANGE/ ROSE**

FUEL LINE BLUE/ RED/ GREEN/ YELLOW/ ORANGE/ PINK

N° DC-COLOR

€ 7



**ROBINET ESSENCE**

FUEL PETCOCK

01 N° 13020100 (2 EXITS/ 2 SORTIES)  
02 N° YC110-0703 (1 EXIT FOR YCF/ 1 SORTIE POUR YCF)

€ 25



**BOUCHON ET JOINT RÉSERVOIR PLASTIQUE**  
GAS CAP AND SEAL

01 N° YC110-0702-01 (YCF ORIGINAL DESIGN)  
02 N° YC110-0720-02

€ 15  
€ 3

# FREINS BRAKES



**PATTE DE FREIN CNC POUR ÉTRIER RADIAL**  
CNC ALUMINUM BRACKET FOR RADIAL BRAKE CALIPER

01 N° YC110-0510-06-SI (AV./FR. FOR DISK 220 MM)  
01 N° YC110-0510-07-SI (AV./FR. FOR DISK 240 MM)  
02 N° YC110-1210-06-SI (ARR./ REAR) € 39

**RESSORT ANTI VIBRATION  
POUR ÉTRIER RADIAL ARRIÈRE**  
REAR SPRING ANTI VIBRATION  
FOR REAR CNC RADIAL BRAKE

03 N° YC110-1256-02 € 5

**RESSORT PLAQUETTE DE FREIN  
POUR ÉTRIER RADIAL AVANT**  
BRAKE PADS SPRING FOR FRONT CNC RADIAL BRAKE

04 N° YC110-0556-02 € 5

**AXE DE PLAQUETTE DE FREIN POUR ÉTRIER RADIAL**  
BRAKE PADS AXLE FOR CNC RADIAL BRAKE

05 N° YC110-0555-02 (AVANT/ FRONT) € 4  
06 N° YC110-1255-02 (ARRIÈRE/ REAR) € 4



**KIT FREIN AVANT RADIAL**  
RADIAL FRONT BRAKE KIT

N° YC110-05012-09BK € 149



**KIT FREIN ARRIÈRE RADIAL**  
RADIAL REAR BRAKE ASSEMBLY

N° YC110-12012-0BK € 149



**MAÎTRE CYLINDRE FREIN AVANT SUPERMOTARD**  
SUPERMOTARD FRONT BRAKE MASTER CYLINDER

N° YC110-0507-01 € 99



**LEVIER FREIN SEUL POUR MAÎTRE CYLINDRE FREIN AVANT SM**  
SM BRAKE LEVER FOR FRONT BRAKE MASTER CYLINDER

N° YC110-0503-02 € 30



**ÉTRIER FREIN CNC RADIAL FACTORY**  
FACTORY BRAKE CALIPER RADIAL CNC

01 N° YC110-1201-06-BK (ARRIÈRE/ REAR)  
02 N° YC110-0502-06-BK (AVANT/ FRONT) € 109



**KIT FREIN AVANT FACTORY (LEVIER RÉGLABLE) 2016-23**  
 FACTORY FRONT BRAKE KIT (ADJUSTABLE LEVER) 2016-23

N° YC110-0501-3101 (SP2/ SP3/ BIGY)

€ 89



**KIT FREIN ARRIÈRE FACTORY 2016-2023**  
 FACTORY REAR BRAKE ASSEMBLY 2016-2023

N° YC110-12012-2601 (SP2/ SP3)  
 N° YC110-12012-2801 (BIGY FACTORY)

€ 90



**KIT FREIN ARRIÈRE HYDRAULIQUE YCF 50 2020-23 (ADAPTABLE SUR LES YCF 50 2012-2019)**

HYDRAULIC REAR BRAKE KIT YCF 50 2020-23 (CAN FIT ON YCF 50 2012-2019)

N° YC50-1214-03

€ 79



**KIT FREIN AVANT HYDRAULIQUE YCF 50 2020-23 (ADAPTABLE SUR LES YCF 50 2012-2019)**

HYDRAULIC FRONT BRAKE KIT YCF 50 2020-23 (can fit on YCF 50 2012-2019)

N° YC50-0511-03

€ 79





**ÉTRIER FREIN AVANT**  
FRONT BRAKE CALIPER

- 01 N° YC110-0501-0205 (DOUBLE PISTON) (START 125-BIGY 125-150 MX) € 59
- 02 N° YC110-0501-0203 (4 PISTONS) € 59
- 03 N° YC50-0502 (YCF 50) € 39
- 08 N° YC110-0501-0207 (SP3 2016-23 - BIGY FACTORY 150-190) € 69

**MAITRE CYLINDRE AVANT**  
FRONT BRAKE MASTER CYLINDER

- 04 N° YC110-0501-0103 (FREINAGE À GAUCHE) € 49
- 04 N° YC110-0501-0104-02 (DOUBLE PISTON) (LITE/ START) € 49
- 05 N° YC110-0501-0101 (4 PISTONS) € 49
- 07 N° YC110-0501-0104-03 (PILOT/ FACTORY/ BIGY 2016-23) € 59

**DURITE FREIN AVANT**  
FRONT BRAKE HOSE

- 06 N° YC110-0501-0325 (FILETAGE AU MAÎTRE CYLINDRE) (LITE/START) € 29
- 06 N° YC110-0501-0327 (BANJO AU MAÎTRE CYLINDRE) (SP2/ SP3/ BIGY)



**KIT FREIN COMPLET AVANT AVEC ÉTRIER DOUBLE PISTON**  
COMPLETE FRONT BRAKE KIT WITH DOUBLE PISTON CALIPER

- N° YC110-0501-1801 (LITE/ START 125)
- N° YC110-0501-3301 (BIGY/ PILOT/ SM F150)

€ 75



**KIT FREIN AVANT COMPLET START F88**  
COMPLETE FRONT BRAKE KIT START F88

- N° YC110-0501-2001 (START 88 2020-23)
- N° YC110-0501-20 (START 88 2010/2019)

€ 75  
€ 75







**ÉTRIER FREIN ARRIÈRE**  
REAR BRAKE CALIPER

- 01 N° YC110-1201-0401 (1 PISTON) (LITE/ START/ PILOT/ BIGY 125-150 MX) € 59
- 02 N° YC110-0501-0203 (4 PISTONS) € 39
- 03 N° YC50-1201 (YCF 50) € 39
- 08 N° YC110-1201-07 (SP3 2016-23/ BIGY FACTORY 150-190) € 69

**MAÎTRE CYLINDRE FREIN ARRIÈRE**  
REAR BRAKE MASTER CYLINDER

- 04 N° YC110-1201021 (Ø 8/ DIST. 40mm) (START) € 30
- N° YC110-1201023 (Ø 10/ DIST. 40mm) (SM 190) € 30
- 07 N° YC110-1201024 ( PILOT/ FACTORY / BIGY ) € 39
- N° YC110-1201026 (Ø 10/ LITE)

**JEU DE CAOUTCHOUCS ÉTRIER FREIN ARRIÈRE**  
SET OF REAR BRAKE CALIPER RUBBER

- 05 N° YC110-120110 € 5

**DURITE FREIN ARRIÈRE Ø 10 ÉTRIER**  
REAR BRAKE HOSE CONNECTION Ø 10 CALIPER

- 06 N° YC110-1201061 (Ø 8 MASTER CYLINDER) 370mm (START)
- 06 N° YC110-1201062 (Ø 8 MASTER CYLINDER) 465mm (PILOT)
- 06 N° YC110-1203-04 (Ø 10/ MASTER CYLINDER) 425 (LITE)
- 06 N° YC110-1201052 (Ø 10/ MASTER CYLINDER) 465mm (SP2)
- 06 N° YC110-1201063 (Ø 10/ MASTER CYLINDER) 515mm (SP3/ BIGY) € 19



**KIT FREIN COMPLET ARRIÈRE 1 PISTON**  
COMPLETE REAR BRAKE ASSEMBLY

- N° YC110-12012-0601 (START) € 79
- N° YC110-12012-3101 (LITE) € 79
- N° YC110-12012-2701 (BIGY) € 79
- N° YC110-12013-0301 (360 mm START 88SE 2020-22) € 79
- N° YC110-12012-2401 (PILOT/ SM F150) € 79



**MAÎTRE CYLINDRE AVEC BOCAL**  
MASTER CYLINDER WITH BOWL

- N° YC110-120102 € 35





**FACTORY**

**PÉDALE DE FREIN PILOT/FACTORY/BIGY AVEC ROULEMENT**

PILOT/FACTORY/BIGY BRAKE PEDAL WITH BEARING

N° YC110-219-03

€ 49



**FACTORY**

**PÉDALE DE FREIN PILOT/FACTORY/BIGY AVEC ROULEMENT**

PILOT/FACTORY/BIGY BRAKE PEDAL WITH BEARING

N° YC110-219-03-BK

€ 49



**START**

**PÉDALE FREIN ALUMINIUM POUR 88/125 START**

ALUMINIUM BRAKE PEDAL FOR 88/125 START

N° YC110-218

€ 49



**FOR 50 ONLY**



**KIT PÉDALE FREIN AU PIED POUR YCF 50 2012-23**

BRAKE PEDAL KIT FOR YCF 50 2012-23

N° YC50-1219

€ 49



**START**

**PÉDALE FREIN ACIER POUR START 88/125**

STEEL BRAKE PEDAL FOR 88/125 START

N° YC110-211

€ 25



**PÉDALE DE FREIN ALUMINIUM HAUT DE GAMME 2010-2011-CLASSIC 2012**

ALUMINIUM BRAKE PEDAL HIGH-RANGE 2010-2011-CLASSIC 2012

N° YC110-215

€ 49



**EMBOU PÉDALE FREIN ALUMINIUM NOIR/ BLEU/ ROUGE/ VERT/ ORANGE**

COLOR REAR BRAKE LEVER TIPS BLACK/ BLUE/ RED/ GREEN/ ORANGE

N° YC110-1223-02-COLOR

€ 15



**PÉDALE DE FREIN ACIER**

STEEL BRAKE PEDAL

N° YC110-217-02 (PILOT/ SM150 2013-23)

€ 25



**CHAPE MAÎTRE CYLINDRE FREIN ARRIÈRE CNC NOIR/ BLEU/ ROUGE/ VERT/ ORANGE**

CNC REAR BRAKE CLEVIS BLACK/ BLUE/ RED/ GREEN/ ORANGE

N° EMC-COLOR

N° EMC01-COLOR (PILOT/ FACTORY/ BIGY 2016-23)

€ 15



**PROTECTION MAÎTRE CYLINDRE FREIN ARRIÈRE POUR LITE/ START 2007-23/ PILOT/ FACTORY 2007-15**

REAR BRAKE MASTER CYLINDER GUARD FOR LITE/ START 2007-23/ PILOT/ FACTORY 2007-15

N° YC110-1224

€ 15



**EMBOU PÉDALE FREIN**

REAR BRAKE LEVER TIPS

01 N° YC110-1223-01 (ACIER/ STEEL)

€ 6

02 N° YC110-1223-02 (ALUMINIUM)

€ 15

**CÂBLE DE PÉDALE DE FREIN ARRIÈRE AVEC GAINÉ (POUR ÉVITER DE TORDRE LA PÉDALE DE FREIN)**

REAR BRAKE PEDAL CABLE WITH SHEATH (TO AVOID BRAKE PEDAL TWISTING)

03 N° YC110-1260-01

€ 8

**RESSORT PÉDALE FREIN**

BRAKE PEDAL SPRING

04 N° YC110-21-01 (ACIER/ STEEL)

04 N° YC110-21-05 (ALUMINIUM)

04 N° YC110-21-06 (ALUMINIUM FACTORY)

€ 5

**FACTORY SP III**

YCF FACTORY DAYTONA® 190 ANIMA  
RIDER : TRISTAN LANE  
TEAM : YCF USA





**DISQUE DE FREIN ENTRAXE 102,5mm Ø INT. 76mm**  
BRAKE DISC CENTRE TO CENTRE DISTANCE 102,5mm INNER Ø 76mm

- Nº YC110-0513-02 (AVANT/ FRONT 220mm) € 39
- Nº YC110-1115-01 (ARRIÈRE/ REAR 200mm) € 39
- Nº YC110-1115-06 (200mm PERCÉ EN 10mm) € 39
- Nº YC110-1115-07 (220mm PERCÉ EN 10mm) € 39



**KIT VIS INOX POUR DISQUE DE FREIN**  
INOX BOLT KIT FOR BRAKE DISC

- Nº KVD € 3,5
- Nº KVDSM10 € 5



**DISQUE FREIN AVANT FLOTTANT 220mm**  
SEMI FLOATING BRAKE ROTOR

- Nº YC110-0613-01-BK € 99



**DISQUE DE FREIN AVANT 240mm AVEC PATTE DE DÉPORT**  
240mm FRONT BRAKE DISC WITH LEG OFFSET

- Nº KS2 € 69



**DISQUE DE FREIN AVANT FLOTTANT 240mm AVEC PATTES DE DÉPORT**  
240mm SEMI FLOATING BRAKE ROTOR WITH CALIPER MOUNTING BRACKETS KIT

- Nº KS2-1 € 129



**JEU DE PLAQUETTES FREIN AV. & AR. POUR YCF 50**  
SET OF BRAKE PADS FRONT & REAR FOR YCF 50

- 01 Nº YC50-0506 (2012-2019) € 15
- 19 Nº YC50-0506-02 (YCF 50 2020-23 HYDRAULIQUE) € 16

**JEU DE PLAQUETTES FREIN ARRIÈRE**  
REAR BRAKE PADS

- 02 Nº YC110-120107
- 03 Nº YC110-120108
- 04 Nº 14030213/4N (YCF 2005)
- 17 Nº YC110-1204-02 (SP 2016-23/ BIGY/ FACTORY 2017-23) € 17

**JEU DE PLAQUETTES FREIN AR. 1 PISTON YCF**  
REAR BRAKE PADS SINGLE 1 PISTON YCF

- 05 Nº YC110-120104 (START 2012-23/ LITE 2016-23) € 17

**JEU DE PLAQUETTES FREIN AVANT YCF 2005**  
FRONT BRAKE PADS YCF 2005

- 06 Nº 14010114/5 € 15

**JEU DE PLAQUETTES FREIN AVANT/ARRIÈRE POUR ÉTRIER 4 PISTONS POUR YCF 2007 ET 88 2009-11**  
BRAKE PADS FRONT/REAR FOR 4 PISTONS CALIPER FOR YCF 2007 AND 88 2009-11

- 08 Nº YC110-0501-0401 € 15

**JEU DE PLAQUETTES FREIN AVANT**  
FRONT BRAKE PADS

- 07 Nº YC110-0501-0405
- 09 Nº YC110-0501-0404
- 10 Nº YC110-0501-0406
- 18 Nº YC110-0501-0416 (SP 2016-23/ BIGY/ FACTORY 2017-23) € 17

**JEU DE PLAQUETTES SIMPLE PISTON POUR YCF 2006**  
BRAKE PADS SINGLE PISTON FOR YCF 2006

- 11 Nº YC110-0501-0402 € 15

**JEU DE PLAQUETTES FREIN AVANT YCF 2008-13**  
FRONT BRAKE PADS YCF 2008-13

- 12 Nº YC110-0501-0403 € 17

**VIS PLAQUETTE FREIN AVANT OU ARRIÈRE**  
FRONT OR REAR BRAKE PADS SCREW

- 13 Nº YC110-1255 (ARRIÈRE/ REAR)
- 14 Nº YC110-0555 (AVANT/ FRONT) € 2

**JEU DE PLAQUETTES FREIN RADIAL AV. & AR.**  
SET OF RADIAL BRAKE PADS FRONT & REAR

- 15 Nº YC110-0506-01 (AVANT/ FRONT)
- 16 Nº YC110-1204-01 (ARRIÈRE/ REAR) € 17



**FACTORY**  
SPECIAL PARTS  
YCF RACING

**CAPOT MAÎTRE CYLINDRE FREIN AVANT CNC**  
NOIR/ BLEU/ ROUGE/ VERT/ ORANGE  
FRONT BRAKE RESERVOIR COVER BLACK/ BLUE/ RED/ GREEN/ ORANGE

N° FBRC-COLOR (ALL YCF MODELS EXCEPT PILOT/ FACTORY 2016-2023)  
N° FBRC01-COLOR (PILOT/ FACTORY/ BIGY 2016-23)

€ 15



**FACTORY**  
SPECIAL PARTS  
YCF RACING

**CAPOT MAÎTRE CYLINDRE FREIN ARRIÈRE CNC**  
NOIR/ BLEU/ ROUGE/ VERT/ ORANGE  
REAR BRAKE RESERVOIR COVER BLACK/ BLUE/ RED/ GREEN/ ORANGE

N° RBRC-COLOR (ALL YCF MODELS EXCEPT PILOT/ FACTORY 2016-2023)  
N° RBRC01-COLOR (PILOT/ FACTORY/ BIGY 2016-23)

€ 15

# BRAS OSCILLANTS SWING ARMS



**DIABOLO CNC NOIR/ BLEU/ ROUGE / VERT/ ORANGE**  
CNC REAR SPOOL BLACK/ BLUE/ RED/ GREEN/ ORANGE

N° KRS-COLOR

€ 17



**FACTORY**  
SPECIAL PARTS  
YCF RACING

**BRAS OSCILLANT MONO ALU RENFORCÉ**  
ALUMINUM REINFORCED MONO SWING ARM

- N° YC110-10015-01 (420mm POUR/ FOR SP2 2014-2023/ SP3 2014-18) € 249
- N° YC110-1001-2101 (460mm POUR/ FOR SP3 2019-23) € 249
- N° YC110-1001-10 (460mm, AXE 12 POUR/ FOR BIGY 2017) € 249
- N° YC110-1001-1601 (460mm, AXE 15 POUR/ FOR BIGY 2018-23) € 249
- N° YC110-1001-23 (490mm, AXE 15 POUR/ FOR BIGY SM 17/17 ou BIGY MX 16/19) € 259



**BRAS OSCILLANT MONO CHROMOLY START**  
START MONO CHROMOLY SWING ARM

- N° YC110-1001-0701 (350mm) (START 88)
- N° YC110-10014-01 (390mm) (START 125)

€ 99



**BRAS OSCILLANT MONO CHROMOLY**  
CHROMOLY MONO SWING ARM

- N° YC110-1001-05 (420mm, AXE 12 POUR/ FOR PILOT 2015-17) € 149
- N° YC110-1001-1701 (420mm, AXE 15 POUR/ FOR PILOT 2018-23)
- N° YC110-1001-1501 (460mm, AXE 15 POUR/ FOR BIGY 2018-23) € 179

€ 149

€ 179



**BRAS OSCILLANT CANTILEVER LITE**  
LITE CANTILEVER SWING ARM

N° YC110-1001-1201

€ 89



**PROTÈGE DISQUE ARRIÈRE RENFORCÉ NYLON**  
REINFORCED NYLON REAR DISC GUARD

N° YC110-1024-04

€ 29



**PROTÈGE DISQUE ARRIÈRE**  
REAR DISC GUARD

N° YC110-1010

€ 15



**VIS ET ÉCROU TENDEUR DE CHAÎNE**  
BOLT AND NUT FOR BLOCK AXLE

01 N° GB5783-M8X40-W (VIS/ SCREW)  
02 N° FB6170-M8-W (ÉCROU/ NUT)

€ 3  
€ 2



**AXE BRAS OSCILLANT**  
AXLE SWING ARM

01 N° YC110-10-03 (Ø 10/ L: 185mm)  
02 N° YC110-10-034 (Ø 12/ L: 192mm)  
02 N° YC110-10-033 (Ø 12/ L: 236mm: FACTORY 2012-23)  
02 N° YC110-10-035 (Ø 12/ L: 240mm: PILOT)  
03 N° YC110-1009-01 (Ø 15: PILOT/ BIGY 2018-23)

€ 6

**ROULEMENT BRAS OSCILLANT**  
SWING ARM BEARING

04 N° 6200/30-10 (Ø EXT, 30/ Ø INT, 10)  
04 N° 6001/28-10 (Ø EXT, 28/ Ø INT, 10)  
04 N° 6001/28-12-08 (Ø EXT, 28/ Ø INT, 12)  
04 N° 6001/28-15-08 (Ø EXT, 28/ Ø INT, 15) (PILOT/ BIGY 2018-23)

€ 6



**ROULETTE CHAÎNE**  
CHAIN TENSIONER

01 N° YC110-2201-02  
01 N° YC50-2201-02 (50E-W88)  
01 N° YC110-2201-03 (SP3)

€ 12  
€ 12  
€ 15

**GUIDE CHAÎNE ARRIÈRE**  
REAR CHAIN GUIDE

02 N° YC110-1004 (PILOT - BIGY)  
03 N° YC110-1005 (START - LITE)

€ 39



**FACTORY**  
SPECIAL PARTS  
YCF RACING

**GUIDE CHAÎNE RENFORCÉ FACTORY 2019-23 ADAPTABLE SUR TOUTES LES PILOT/ FACTORY/ BIGY**

2019-23 FACTORY REINFORCED CHAIN GUIDE SUITABLE FOR ALL PILOT/ FACTORY/ BIGY

N° YC110-1018-04

€ 45



**PATIN CHAÎNE R START 2011-2023**

CHAIN SLIDER FOR R START 2011-2023

01 N° YC110-10-023

€ 15

**PATIN BRAS OSCILLANT POUR BRAS ALU 420mm OU 460mm 2011-2023**

SWING ARM SLIDER FOR 420mm OR 460mm ALUMINIUM ARM 2011-2023

02 N° YC110-10-025

€ 15

**PATIN BRAS OSCILLANT CANTILEVER LITE**

LITE CANTILEVER SWING ARM SLIDER

03 N° YC110-1005-02

€ 15

**PATIN CHAÎNE COURT POUR BRAS CANTILEVER**

SHORT CHAIN SLIDER ADAPTABLE FOR CANTILEVER ARM

04 N° YC110-10-021

€ 10

# AMORTISSEURS SHOCK ABSORBERS

**FACTORY**  
SPECIAL PARTS  
YCF RACING



## AMORTISSEUR SHOCK ABSORBER

01	N° YC50-0404-03 (200mm YCF 50)	€ 89
02	N° YC110-0404-82 (270mm CANTILVER - LITE 88 - 125)	€ 129
03	N° YC110-0404-15 (265mm MONO ARM/ BRAS - START F88)	€ 129
03	N° YC110-0404-14 (270mm MONO ARM/ BRAS - START F125)	€ 129
03	N° YC110-0404-17 (310mm MONO ARM/ BRAS - PILOT 125/150 2013-20 & SM150 2013-23)	€ 139
03	N° YC110-0404-81 (330mm MONO ARM/BRAS PILOT 125/150 2020-23)	€ 139
03	N° YC110-0404-67 (355mm MONO ARM/ BRAS - BIGY)	€ 139
04	N° YC110-0404-07 (280mm RÉGLABLE/ ADJUSTABLE)	€ 199
04	N° YC110-0404-16 (330mm RÉGLABLE/ ADJUSTABLE - SP2)	€ 199
04	N° YC110-0404-68 (355mm RÉGLABLE/ ADJUSTABLE - BIGY)	€ 199

## ENTRETOISE D'AMORTISSEUR Ø 12 SHOCK ABSORBER SPACERS Ø 12

05	N° YC110-04192 (RSP, CLASSIC, FACTORY 2010-2022)	€ 6
06	N° YC110-0419 (START/ PILOT 2010-2022)	€ 4



## AMORTISSEUR DNM DNM SHOCK ABSORBER

N° YC110-0404-83	270mm ressort/spring 800lbs	€ 319
N° YC110-0404-84	270mm ressort/spring 1000lbs	€ 339
N° YC110-0404-35	310mm ressort/spring 1000lbs	€ 339
N° YC110-0404-59	330mm ressort/spring 1000lbs	€ 339
N° YC110-0404-86	345mm ressort/spring 1200lbs (BIGY SM 190)	€ 319



## KIT RABASSE AMORTISSEUR HEIGHT ADJUSTMENT KIT

01	N° YC110-1033-01 (START 88S-125-125S)	€ 59
02	N° YC110-1030-02 (LITE)	€ 59



## RESSORT PLUS SOUPLE ET PLUS DUR SOFTER AND HARDER SPRING

01	N° YC110-0417-22-WH (START/ SM 88-125)	€ 39
	N° YC110-0417-23-WH (PILOT 125-150/ SM 150) (SOUPLE 600 lbs)	€ 39
02	N° YC110-0417-27-BK (START/ SM 88-125)	€ 39
	N° YC110-0417-28-BK (PILOT 125-150/ SM 150) (DUR 800 lbs)	€ 39



## BAVETTE D'AMORTISSEUR YCF YCF MUD FLAP

N° YC110-0460-01	(POUR/FOR PILOT/ FACTORY/ BIGY)	€ 15
------------------	---------------------------------	------

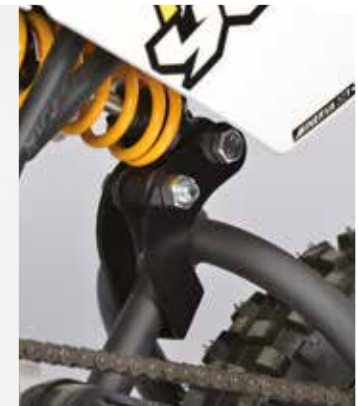



# ROUES, JANTES & MOYEUX WHEELS, RIMS & HUBS



**KIT ROUE SUPERMOTO MOBSTER 12"**  
(2.15 X 12" AVANT/ 3.00 X 12" ARRIÈRE)  
MOBSTER SUPERMOTO PAIR OF WHEELS SET 12"  
(2.15 X 12" FRONT/ 3.00 X 12" REAR)

N° KWMOBSTER01-BK

€ 269



**ROUE SUPERMOTO ALU 17-17**  
(VENDUE AVEC DISQUE DE FREIN & COURONNE)  
SUPERMOTO WHEEL ALU  
(SOLD WITH BRAKE DISC & SPROCKET)

N° YC110-0601-32 (2.50x17 AVANT/ FRONT)  
N° YC110-1101-70 (3.50x17 ARRIÈRE/ REAR)

€ 229  
€ 249



**ROUE SUPERMOTO ALU**  
(VENDUE AVEC DISQUE DE FREIN & COURONNE)  
SUPERMOTO WHEEL ALU  
(SOLD WITH BRAKE DISC & SPROCKET)

N° YC110-0601-93 (2.50x14" AVANT/ FRONT)  
N° YC110-1101-73 (3.00x14" ARRIÈRE/ REAR)

€ 159  
€ 199



**ROUE SUPERMOTO (ACIER)**  
(VENDUE AVEC DISQUE DE FREIN & COURONNE)  
SUPERMOTO STEEL WHEEL  
(SOLD WITH BRAKE DISC)

N° YC110-06017 (1,85x12" AVANT/ FRONT)  
N° YC110-11014 (2,15x12" ARRIÈRE/ REAR)

€ 119  
€ 129



**KIT ROUE SUPERMOTO YCF 10"**  
(2.15 X 10" AVANT/ 2.50 X 10" ARRIÈRE)  
YCF SUPERMOTO WHEEL SET 10"  
(2.15 X 10" FRONT/ 2.50 X 10" REAR)

N° YC110-0625-01-BK

€ 219



**KIT ROUE YCF 12"**  
(2.15 X 12" AVANT/ 2.75 X 12" ARRIÈRE)  
YCF WHEEL SET 12"  
(2.15 X 12" FRONT/ 2.75 X 12" REAR)

N° YC110-0626-01-BK

€ 249

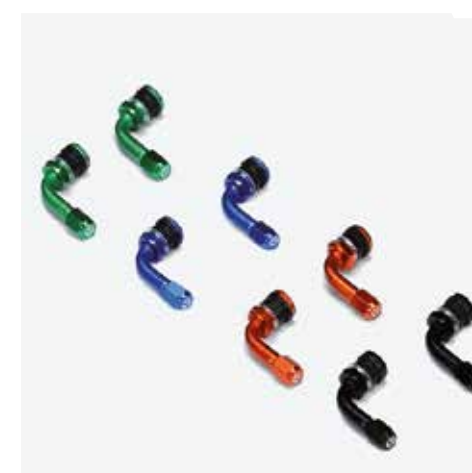

**VALVE COUDE 90° NOIR/ BLEU/ ROUGE/ VERT/ ORANGE**  
YCF 90° INNER TIRE VALVES BLACK/ BLUE/ RED/ GREEN/ ORANGE

N° ITV02-COLOR

€ 10



10 12 14

**ROUE ACIER POUR AXE DE ROUE DE 15" AVEC RAYONS RENFORCÉS 4mm**

STEEL WHEEL FOR 15" WHEEL AXLE WITH 4mm REINFORCED SPOKES

- Nº YC110-0601-2901 (AVANT/ FRONT 12") € 119
- Nº YC110-0601-30-BK (AVANT/ FRONT 14") € 119
- Nº YC110-0601-0801 (88CC : AVANT/FRONT 10") € 119
- Nº YC110-1101-34-BK (ARRIÈRE/ REAR 12") € 149
- Nº YC110-1101-01A (ARRIÈRE/ REAR 10") € 149



FOR 50 ONLY

10

**ROUE AVANT OU ARRIÈRE COMPLÈTE YCF 50**

COMPLETE FRONT OR REAR WHEEL FOR YCF 50

- Nº YC50-0601-0401 (AVANT/ FRONT) € 99
- Nº YC50-1101-0401 (ARRIÈRE/ REAR) € 139



12 14

**ROUE COMPLÈTE ACIER RENFORCÉE POUR AXE DE ROUE DE 15", MOYEURS ARRIÈRE AVEC 5 VIS DE FIXATION POUR COURONNE**

COMPLETE REINFORCED STEEL WHEEL AXLE 15", REAR HUB WITH 5 SCREWS FIXATION FOR SPROCKET

- Nº YC110-0601-5B (AVANT/ FRONT 14") € 129
- Nº YC110-1101-2D (ARRIÈRE/ REAR 12") € 159



FOR 50 ONLY

10

**ROUE COMPLÈTE AVEC MOYEURS CNC NOIRE/ BLEUE/ ROUGE/ VERTE/ ORANGE**

COMPLETE WHEEL WITH CNC HUB BLACK/ BLUE/ RED/ GREEN/ ORANGE

- Nº YC50-0611-01-COLOR (AVANT/ FRONT) € 129
- Nº YC50-1101-COLOR (ARRIÈRE/ REAR) € 149



14 17

**ROUE COMPLÈTE ACIER RENFORCÉE POUR AXE DE ROUE DE 15", MOYEURS ARRIÈRE AVEC 5 VIS DE FIXATION POUR COURONNE**

COMPLETE REINFORCED STEEL WHEEL AXLE 15", REAR HUB WITH 5 SCREWS FIXATION FOR SPROCKET

- Nº YC110-0601-39-BK (AVANT/ FRONT 17") € 139
- Nº YC110-1101-29-BK (ARRIÈRE/ REAR 14") € 149



16 19

**ROUE AVANT OU ARRIÈRE COMPLÈTE 16"/19" CERCEAU ALUMINIUM**

COMPLETE FRONT OR REAR WHEEL 16"/19" ALUMINIUM RIM

- Nº YC110-0601-34-BK (1,60x19" AVANT/ FRONT) € 199
- Nº YC110-1101-72-BK (1,85 x16" ARRIERE/ REAR) € 259

ROUE COMPLÈTE RENFORCÉE, MOYEUX CNC,  
CERCEAU ALU, 7116, VENDUE AVEC DISQUE & COURONNE  
NOIRE/ BLEUE/ ROUGE/ VERTE/ ORANGE

COMPLETE REINFORCED WHEEL, CNC HUB, ALU,  
7116 RIM (SOLD WITH BRAKE DISC & SPROCKET)  
BLACK/ BLUE/ RED/ GREEN/ ORANGE

N° YC110-0601-40-COLOR (AVANT/ FRONT 17") € 179  
N° YC110-1101-32-COLOR (ARRIÈRE/ REAR 14") € 229

14 17

**FACTORY**  
SPECIAL PARTS  
YCF RACING



**AI 7116**

**YCF**



**7116**



**CERCEAU DE ROUE ALU. 7116**

ALUMINUM 7116 M SHAPE RIM

**ROUE COMPLÈTE RENFORCÉE, MOYEURS CNC, CERCEAU ALU, 7116, VENDUE AVEC DISQUE & COURONNE NOIRE/ BLEUE/ ROUGE/ VERTE/ ORANGE**

COMPLETE REINFORCED WHEEL, CNC HUB, ALU, 7116 RIM (SOLD WITH BRAKE DISC & SPROCKET) BLACK/ BLUE/ RED/ GREEN/ ORANGE

N° YC110-06012-COLOR (AVANT/ FRONT 12")

N° YC110-0601-37 (AVANT/ FRONT 14")

N° YC110-1101-25 (ARRIÈRE/ REAR 12")

€ 149

€ 169

€ 219

N° YC110-1107-BK (1,85x12" AV./ FRONT - AR./ REAR)

N° YC110-1107-16-SI (1,85x12" AV./ FRONT)

N° YC110-0617-24-BK (2,50x14" AV./ FRONT)

N° YC110-0617-24-SI (1,40x14" AV./ FRONT)

N° YC110-0617-40-BK (1,60x17" AV./ FRONT)

N° YC110-1107-32-BK (1,85x14" AR./ REAR)

N° YC110-0617-41-BK (2,50x17")

N° YC110-1107-54-BK ( 3,50x17")

N° YC110-1107-55-BK ( 2,15x16")

N° YC110-0617-42-BK (1,60X19")

€ 59

€ 79

€ 79

€ 59

€ 59

€ 139

€ 149

€ 99

€ 99



**CERCEAU DE ROUE ACIER POUR RAYON 4mm**  
STEEL RIM WITH 4mm SPOKES

- N° YC110-1107-34-BK (1,85X12 AV./ FRONT - AR./ REAR) € 30
- N° YC110-1101-014 (2,15X12 AV./ FRONT - AR./ REAR) € 30
- N° YC110-0617-19-BK (1,40x12 AV./ FRONT) € 30
- N° YC110-0617-30-BK (1,40x14 AV./ FRONT) € 30
- N° YC110-0617-39-BK (1,60x17 AV./ FRONT) € 30
- N° YC110-1107-29-BK (1,85x14 AR./ REAR) € 30



**ROULEMENT DE ROUE AVANT OU ARRIÈRE**  
FRONT OR REAR WHEEL BEARING

- 01 N° 96140-6202-2Z € 6

**JOINT SPY DE ROUE**  
WHEEL OIL SEAL

- 02 N° YC50-0610 (Ø22X31.5X5) (POUR/ FOR YCF 50)
- 02 N° YC110-0610 (Ø25X35X6.5)  
(POUR MOYEURS CNC 2012/ FOR CNC HUB)
- 02 N° YC110-0611 (Ø23X35X5) (POUR MOYEURS  
INJECTÉ-CNC/ FOR MOLDED-CNC HUB) € 6

**GRIPSTER ARRIÈRE OU AVANT**  
REAR OR FRONT RIM LOCK

- 03 N° GRIPSTERAR-R (ARRIÈRE/ REAR)
- 03 N° GRIPSTERA-V-R (AVANT/ FRONT) € 15



**JEU DE RAYONS AVANT OU ARRIÈRE 4mm**  
FRONT OR REAR SET OF SPOKES 4mm

- AVANT/ FRONT:
- N° JR10-10.6 (50A/ 50E)
  - N° JR12-12.1-8K (88E/ START 88SE)
  - N° JR10-10.1-8K (LITE 88)
  - N° JR14-14.8-8K (LITE 125/ START 125S/ START 125SE  
/ PILOT 125/ PILOT 150)
  - N° JR14-15.0-8K (SP2/ SP3)
  - N° JR17-18.4-8K (BIGY 125/ 150)
  - N° JR17-18.5-8K (BIGY F150/ 190D/ 190ZE)
  - N° JR12-12.5 (SM)
  - N° JR19-21.3-8K (BIGY 19")
  - JR16-17.5-8K (BIGY 16") € 25

- ARRIÈRE/ REAR:
- N° JR10-10.5 (50A/ 50E)
  - N° JR10-10.4-8K (88E/ LITE 88/ START 88SE)
  - N° JR12-12.8-8K (LITE 125/ START 125S/ START 125SE  
/ PILOT 125/ PILOT 150)
  - N° JR12-13.5-8K (SP2/ SP3)
  - N° JR14-15-8K (BIGY 125/ 150)
  - N° JR14-15.1-8K (BIGY F150/ 190D/ 190ZE)
  - N° JR12-12.6-10K (SM) € 25



**AXE DE ROUE AVANT OU ARRIÈRE**  
FRONT OR REAR WHEEL AXLE

- 01 N° YC110-11-075 (FACTORY 2011-2023)
- 02 N° YC110-11-07 (ARRIÈRE/ REAR)
- 03 N° YC110-06-06 (AVANT/ FRONT)
- 04 N° YC110-06-061 (TYPE MARZOCCHI®) € 7



**COUVRE RAYON (KIT DE 38 PCS AVANT 215 MM/ 38 PCS ARRIÈRE 190mm)**  
BLEU/ ROUGE/ VERT/ JAUNE/ ORANGE/ ROSE

SPOKE SKIN SET (INCLUDES 38 FRONT PCS-215mm & 38 REAR PCS-190mm)  
BLUE/ RED/ GREEN/ YELLOW/ ORANGE/ PINK

N° SPKAS01-COLOR

€ 15



**MOYEU ROUE AVANT OU ARRIÈRE CNC NOIR/ BLEU/ ROUGE/ VERT/ ORANGE**

WHEEL HUB CNC FRONT OR REAR BLACK/ BLUE/ RED/ GREEN/ ORANGE

- 01 N° YC110-0622-22-COLOR (AVANT/ FRONT) € 99  
 02 N° YC110-1122-16-COLOR (ARRIÈRE/ REAR) € 119

**JEU ENTRETOISES DE ROUE CNC POUR MOYEU INJECTÉE LITE/ START/ PILOT/ BIGY MX125/150 NOIRES/BLEUES/ ROUGES/ VERTES/ ORANGES**

SET OF CNC WHEEL SPACERS FOR CASTING HUB LITE/ START/ PILOT/ BIGY MX125/150 BLACK/ BLUE/ RED/ GREEN/ ORANGE

- 03 N° ERC1AV-COLOR (AVANT/ FRONT 15x22x33 & 15x22x23) € 15  
 03 N° ERC1AR-COLOR (ARRIÈRE/ REAR 15x22x38 & 15x22x29)

**ENTRETOISE DE ROUE**

WHEEL SPACER

- 04 N° YC110-06-052 (AVANT GAUCHE/ FRONT LEFT) Ø 15X22X33 LITE/ START/ PILOT/ BIGY MX125-150  
 04 N° YC110-06-047 (AVANT DROITE/ FRONT RIGHT) Ø 15X22X23 LITE/ START/ PILOT/ BIGY MX125-150  
 04 N° YC110-11-052 (ARRIÈRE GAUCHE/ REAR LEFT) Ø 15X22X38 LITE/ START/ PILOT/ BIGY MX125-150  
 04 N° YC110-11-041 (ARRIÈRE DROITE/ REAR RIGHT) Ø 15X22X29 LITE/ START/ PILOT/ BIGY MX125-150 € 5

**ENTRETOISE DE ROUE MOBSTER**

MOBSTER WHEEL SPACER

- N° FB13-15X22X19-W (AVANT DROITE) € 6  
 N° FB13-15X22X23-W (ARRIÈRE DROITE)  
 N° FB13-15X22X28-W (AVANT GAUCHE)  
 N° FB13-15X22X34-W (ARRIÈRE GAUCHE) € 22  
 N° KFB13-15

**ENTRETOISE CENTRALE DE MOYEU**

CENTRAL HUB SPACER

- 05 N° YC110-0601-02 (CENTRAL AVANT/ FRONT) Ø 16x22x44  
 05 N° YC110-0601-021 (CENTRAL AVANT/ FRONT) Ø 16x21x53  
 05 N° YC110-0601-022 (CENTRAL AVANT/ FRONT) Ø 15x22x43

- 05 N° YC110-1101-03 (INT, ARRIÈRE/ INNER REAR) Ø 16x21x84  
 05 N° YC110-1101-04 (INT, ARRIÈRE/ INNER REAR) Ø 16X21X64  
 05 N° YC110-1101-05 (INT, ARRIÈRE/ INNER REAR) Ø 16x21x59  
 05 N° YC110-1101-06 (INT, ARRIÈRE/ INNER REAR) Ø 16x21x74 € 5

**ENTRETOISE SP3 2019 (TÉ 170 mm)**

WHEEL SPACER

- 04 N° YC110-0609-08 (AVANT DROITE/ FRONT RIGHT)  
 04 N° YC110-0610-08 (AVANT GAUCHE/ FRONT LEFT) € 7

**FACTORY**SPECIAL PARTS  
YCF RACING**AI 7116**



# PNEUS TIRES



**CHAMBRE À AIR RENFORCÉE 4mm**  
REINFORCED TUBE 4mm

- 01 N° CHAMBRE10RENF (Ø 10" FRONT-REAR/ AV,-AR,) € 13
- 01 N° CHAMBRE12RENF (Ø 12" FRONT-REAR/ AV,-AR,) € 13
- 01 N° CHAMBRE14RENF (Ø 14" AV./ FRONT) € 13
- 01 N° CHAMBRE14ARRENF (Ø 14" AR./ REAR) € 16
- 01 N° CHAMBRE17RENF (Ø 17" AV./ FRONT) € 16

**CHAMBRE À AIR STANDARD**  
STANDARD TUBE

- 01 N° CHAMBRE10-2,5 (Ø 10" POUR/ FOR YCF 50) € 10
- 01 N° CHAMBRE12AV (Ø 12" AVANT/ FRONT) € 13
- 01 N° CHAMBRE16AR € 16
- 01 N° CHAMBRE19AV € 16

**FOND JANTE**  
TIRE LINING

- 02 N° YC110-11-01 (ROUE/ WHEEL 10/12")
- 02 N° YC110-06-01 (ROUE/ WHEEL 14")
- 02 N° YC110-06-07 (ROUE/ WHEEL 17") € 2



**BOUCHON DE VALVE CNC**  
**NOIR/ BLEU/ ROUGE/ VERT/ ORANGE**  
VALVE CAP SET  
BLACK/ BLUE/ RED/ GREEN/ ORANGE

N° TVC-COLOR € 5



**PNEU AVANT CROSS 2,50/10**  
FRONT CROSS TIRE IN 2,50/10

N° 250/10 € 29



**PNEU AVANT CROSS EN 60/100/12**  
FRONT CROSS TIRE IN 60/100/12

N° 60/100/12 € 32



**PNEU ARRIÈRE CROSS EN 90/100/14**  
REAR CROSS TIRE IN 90/100/14

N° 90/100-14P398 € 45



**PNEU ARRIÈRE CROSS EN 3,00/10**  
REAR CROSS TIRE IN 3,00/10

N° 300/10 € 36



**PNEU ARRIÈRE CROSS EN 80/100/12**  
REAR CROSS TIRE IN 80/100/12

N° 300/12 € 32



**PNEU AVANT CROSS EN 70/100/17**  
FRONT CROSS TIRE IN 70/100/17

N° 70/100-17P397 € 45



**PNEU AVANT CROSS EN 60/100/14**  
FRONT CROSS TIRE IN 60/100/14

N° 60/100/14 € 32



**PNEU ARRIÈRE CROSS EN 90/100-16P52**  
REAR CROSS TIRE IN 90/100-16P52

N° 90/100-16P52 € 49



**PNEU 90/90/10**  
TIRE 90/90/10

N° 90/90/10 € 45



**PNEU AVANT CROSS EN 70/100-19P51**  
FRONT CROSS TIRE IN 70/100-19P51

N° 70/100-19P51 € 46



**KENDA**

10 12



**PNEU KENDA® SUPERMOTARD K702**  
KENDA® SUPERMOTO TIRE K702

Nº 90/90-10K702  
Nº 100/90-10K702  
Nº 110/70-12K702  
Nº 120/70-12K702

€ 69  
€ 69  
€ 79  
€ 79

**ARRO™**



14

**ARRO™**



17

**PNEU ARRO® SPIDER CROSS ARR, EN 90/100/14**  
SPIDER ARRO® TIRE TRAR 90/100/14

Nº 90/100/14 ARRO

€ 59

**PNEU ARRO® SPIDER® CROSS AVANT EN 70/100/17**  
SPIDER ARRO® TIRE FRONT 70/100/17

Nº 70/100/17 ARRO

€ 55

**ARRO™**



10

**PNEU ARRO® SPIDER CROSS EN 300/10**  
SPIDER ARRO® TIRE 300/10

Nº 300/10 ARRO

€ 40

**ARRO™**



12

**PNEU ARRO® SPIDER CROSS AVANT EN 60/100/12**  
SPIDER ARRO® TIRE FRONT 60/100/12

Nº 60/100/12 ARRO

€ 39

**ARRO™**



12

**PNEU ARRO® SPIDER CROSS ARR, EN 80/100/12**  
SPIDER ARRO® TIRE REAR 80/100/12

Nº 80/100/12ARRO

€ 55

**ARRO™**



14

**PNEU ARRO® SPIDER CROSS AVANT EN 60/100/14**  
SPIDER ARRO® TIRE FRONT 60/100/14

Nº 60/100/14ARRO

€ 49

17

**PNEU AVANT SUPERMOTARD KENDA® K711**  
FRONT SUPERMOTO TIRE KENDA K711

Nº 110/70-17K711

€ 99

17

**PNEU ARRIÈRE SUPERMOTARD KENDA® K711**  
REAR SUPERMOTO TIRE KENDA K711

Nº 130/70-17K711

€ 109

# REPOSE-PIEDS & SABOTS FOOT PEGS & SKID PLATES



**BARRE DE REPOSE-PIED**  
FOOT PEGS MOUNT BAR

N° YC110-0901-01 (GAMME START/ START RANGE) € 29



**RÉSERVOIR RÉCUPERATEUR DE LIQUIDE  
AVEC SEPARATEUR HUILE/ ESSENCE**  
RECUPERATOR TANK WITH SEPARATOR OIL/ GAZ

N° YC110-0816-02 € 39



**PLATINE RÉGLABLE AVEC REPOSE PIED SUPERMOTARD**  
SUPERMOTARD ADJUSTABLE FOOT PEGS KIT

N° YC110-0919-01 € 69



**SABOT MOTEUR ACIER**  
STEEL SKID PLATE

N° YC110-202-01 (ACIER/ STEEL 88/125/140) € 39  
N° YC110-0905-02 (ACIER/ STEEL BIGY 190ZE) € 49



**SABOT POUR FACTORY**  
SKID PLATE FOR FACTORY

N° YC110-207-12 (LITE/START/PILOT) (kickstart model)  
N° YC110-207-03 (FACTORY SP1)  
N° YC110-207-04 (FACTORY SP2)  
N° YC110-207-05 (FACTORY SP3) € 49



**SABOT RÉCUPERATEUR HUILE SUPERMOTARD EN FIBRE  
DE VERRE BLANC/ NOIR**  
RACE BELLY PAN WHITE/ BLACK

N° YC110-202-03-WH € 79  
N° YC110-202-03-BK € 79  
(Adaptable sur toute la gamme YCF/ fit on all YCF range)



**JEU DE REPOSE-PIED ALUMINIUM NOIR/ BLEU/ ROUGE/ VERT/ ORANGE**  
ALUMINUM FOOT PEGS BLACK/ BLUE/ RED/ GREEN/ ORANGE

N° RPALU-COLOR € 69

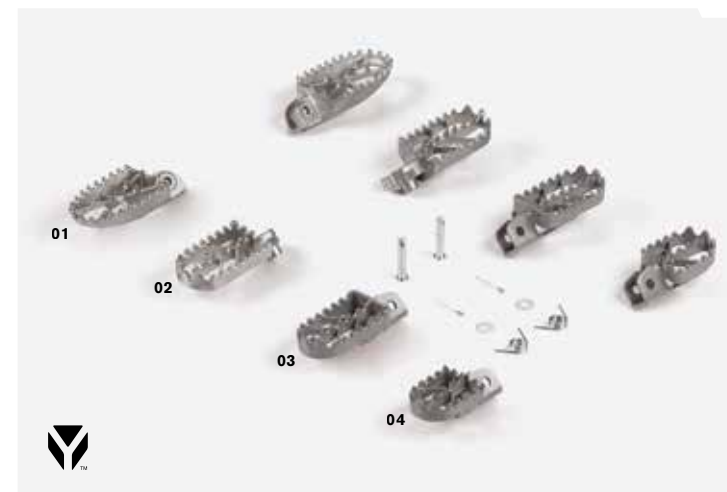

**JEU DE REPOSE-PIED**  
FOOT PEGS SET

01 N° YC110-0902/05 (INOX LARGE/ LARGE STAINLESS STEEL)  
02 N° YC110-0902/04 (INOX/ STAINLESS STEEL) € 49  
03 N° YC110-0902/13 (ACIER/ STEEL)  
04 N° YC110-0902/06 (SUPERMOTO) € 29



**KIT COMPLET PROTECTION TEFLON SUPERMOTO**  
SUPERMOTO TEFLON PROTECTION SET

N° KS1 € 59



**KIT PATIN TEFLON SUPERMOTO**  
SUPERMOTO TEFLON SET

N° KS4 € 35



**KIT BOCAL RÉCUPÉRATEUR HUILE ET ESSENCE SUPERMOTO**  
SUPERMOTO OIL AND FUEL RECUPERATOR KIT

N° KS3 € 29

## ↓ SÉLECTEURS SHIFT LEVERS



**SÉLECTEUR ALUMINIUM CNC AVEC DÉPORT POUR AXE SÉLECTEUR COURT**  
NOIR/ BLEU/ ROUGE/ VERT/ ORANGE  
ALUMINUM CNC GEAR LEVER WITH EXTENSION FOR SHORT LEVER SHAFT  
BLACK/ BLUE/ RED/ GREEN/ ORANGE

01 N° STMD-COLOR € 39

**SÉLECTEUR ALUMINIUM NOIR/ BLEU/ ROUGE/ ORANGE/ VERT**  
ALUMINUM SHIFT LEVER BLACK/ BLUE/ RED/ ORANGE/ GREEN

02 N° 24700-COLOR € 29



**KICK ACIER ORIGINE**  
ORIGINAL STEEL KICKSTARTER

01 N° 43451/152FMH (Ø 13mm)  
01 N° 43452/152FMH (Ø 16mm) € 19

**KICK ACIER RENFORCÉ**  
REINFORCED KICKSTARTER

02 N° YC140-27500SI (Ø 13mm)  
02 N° YC140-27600SI (Ø 16mm) € 50

**RESSORT/ BILLE/ VIS POUR KICK**  
BALL, SPRING, AND SCREW FOR KICKSTARTER

03 N° KVK € 3



**SÉLECTEUR ACIER REPLIABLE**  
FOLDABLE STEEL SHIFT LEVER

01 N° 24700/152FMI/3V (AVEC DÉPORT/ WITH EXT.)  
01 N° 24700/152FMH/02 (190 ZONGSHEN ENGINE)  
02 N° 24700/152FMH/03 € 15

**SÉLECTEUR ACIER REPLIABLE ET RÉGLABLE**  
FOLDABLE & ADJUSTABLE STEEL SHIFT LEVER

03 N° 24700-D (AVEC DÉPORT/ WITH EXT.)  
04 N° 24700-SD € 17

# KIT CHAÎNE & TRANSMISSION

## SPROCKET KITS & TRANSMISSIONS

SPECIAL PARTS  
YCF RACING



### COURONNE ACIER Ø INTÉRIEUR 75 - ENTRAXE COURONNE 92 - 5 TROUS DE FIXATION POUR FACTORY 2016-23

STEEL SPROCKET INNER Ø 75 - SPROCKET CENTRE TO CENTRE DISTANCE 92 - 5 HOLES FIXATION FOR FACTORY 2016-23

N° YC110-11-062/41 (41 DENTS/ TEETH)  
N° YC110-11-062/45 (45 DENTS/ TEETH)

€ 17

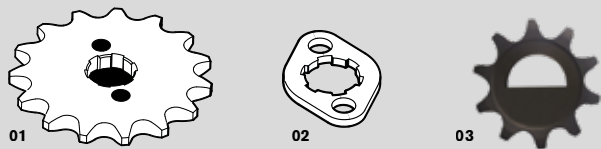

### PIGNON SORTIE BOÎTE & PLAQUE PIGNON

COUNTERSHAFT SPROCKET & SPROCKET PLATE

01 N° 22711/152FMI14 (Ø 20 PIGNON 14 DENTS/ SPROCKET 14 TEETH) € 9  
01 N° 22711/152FMI15 (Ø 20 PIGNON 15 DENTS/ SPROCKET 15 TEETH) € 9  
02 N° 22712/152FMH (Ø 17 PLAQUE PIGNON/ SPROCKET PLATE) € 6  
02 N° 22712/152FMI (Ø 20 PLAQUE PIGNON/ SPROCKET PLATE) € 6  
03 N° RS35/10T (PIGNON 10 DENTS YCF50E/ YCF50E SPROCKET 10 TEETH) € 15  
03 N° RS35/10T-01 (PIGNON 10 DENTS W88 2020-21/ W88 2020-21 SPROCKET 10 TEETH) € 15  
03 N° RS35-11T-01 (PIGNON 420 11 DENTS W88 2022 / W88 2022 SPROCKET 11 TEETH 420) € 15

SPECIAL PARTS  
YCF RACING



### CHAÎNE RENFORCÉE 420 110 MAILLONS BLEUE/ ROUGE/ VERTE/ JAUNE/ ORANGE

REINFORCED CHAIN 420 110 LINKS BLUE/ RED/ GREEN/ YELLOW/ ORANGE

N° 420DX-110T-COLOR  
N° 420DX-116T-COLOR (BIGY)

€ 22  
€ 25

SPECIAL PARTS  
YCF RACING

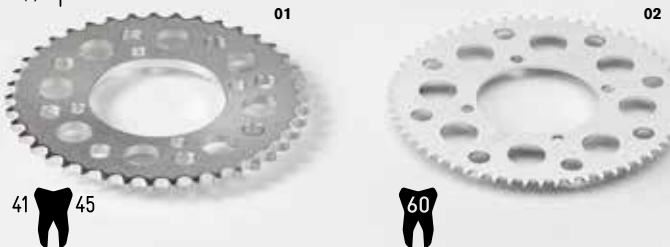

### COURONNE ACIER Ø INTÉRIEUR 75 - ENTRAXE COURONNE 92

STEEL SPROCKET INNER Ø 75 - SPROCKET CENTRE TO CENTRE DISTANCE 92

01 N° YC110-11-06/41 (41 DENTS/ TEETH) € 17  
01 N° YC110-11-06/45 (45 DENTS/ TEETH) € 17  
YC110-11-06/47 (47 DENTS / TEETH) € 17  
02 N° YC110-11-05/60 (60 DENTS/ TEETH - YCF 50E/ W88) € 29

SPECIAL PARTS  
YCF RACING



### PIGNON SORTIE BOÎTE ANTI BOUE Ø 17

ANTI MUD COUNTERSHAFT SPROCKET Ø 17

N° 22711/152FMZ13 (13 DENTS/ TEETH)  
N° 22711/152FMZ14 (14 DENTS/ TEETH)  
N° 22711/152FMZ15 (15 DENTS/ TEETH)  
N° 22711/152FMZ16 (16 DENTS/ TEETH)  
N° 22711/152FMZ17 (17 DENTS/ TEETH) € 9  
N° 420H/10T (10 DENTS/ TEETH) (YCF 50A) € 10

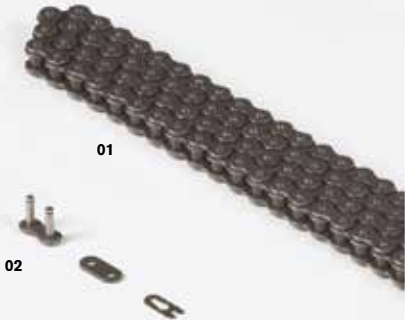

### CHAÎNE 420 ET RS35

CHAIN 420 AND RS35

01 N° 420H-104T (104 MAILLONS/ LINKS) € 17  
01 N° 420H-110T (110 MAILLONS/ LINKS) € 17  
01 N° 420H-116T (116 MAILLONS/ LINKS BIGY) € 17  
01 N° 420H-120T (120 MAILLONS/ LINKS BIGY 16-19) € 35  
01 N° RS35-114T (114 MAILLONS/ LINKS 50E) € 19

### ATTACHE RAPIDE

CHAIN JOINING LINK

02 N° AR-420  
02 N° AR-35 (YCF 50E) € 2,5



37 39 41 43 45 47

**COURONNE ALU. TAILLÉE DANS LA MASSE DISPONIBLE EN 37, 39, 41, 43, 45, 47 DENTS NOIRE/ BLEUE/ ROUGE/ VERTE/ ORANGE Ø INTÉRIEUR 75 - ENTRAXE COURONNE 92**

BILLET ALUMINUM SPROCKET AVAILABLE IN 37, 39, 41, 43, 45, 47 TEETH BLACK/ BLUE/ RED/ GREEN/ ORANGE INNER Ø 75 - SPROCKET CENTRE TO CENTRE DISTANCE 92

N° CA06R+TEETH-COLOR (YCF50A - LITE - START - PILOT - SM)

€ 39



**KIT VIS COURONNE**  
SCREW SET FOR SPROCKET

- 01 N° KVC € 3
- 02 N° KVC-1 (TÊTE FRAISÉE/ FLAT HEAD) € 3
- 04 N° KVC-2 (KIT VIS PLATES/ SPROCKET BOLT KIT FLAT HEAD) € 4

**BLOC COURONNE**  
BLOCK SPROCKET

03 N° YC110-11-03

€ 3



**TENDEUR CHAÎNE CNC NOIR/ BLEU/ ROUGE/ VERT/ ORANGE**  
CNC AXLE BLOCK BLACK/ BLUE/ RED/ GREEN/ ORANGE

- 01 N° TC07-COLOR (Ø 15) (POUR BRAS ACIER/ FOR STEEL SWING ARM)
- 02 N° TC12-COLOR (POUR BRAS ALU/ FOR ALU SWING ARM - 2011-2023)
- 03 N° TC-COLOR (Ø 12 RED OR BLACK ONLY/ ROUGE OU NOIR SEULEMENT) € 19



39 41 43 45 47

**COURONNE ALU, TAILLÉE DANS LA MASSE - 5 TROUS DE FIXATION POUR FACTORY 2016-2023 - DISPONIBLE EN 39, 41, 43, 45, 47 DENTS NOIRE/ BLEUE/ ROUGE/ VERTE/ ORANGE - Ø INTÉRIEUR 75 - ENTRAXE COURONNE 92**

BILLET ALUMINUM SPROCKET - 5 HOLE FIXATION FOR FACTORY 2016-2023 - AVAILABLE IN 39, 41, 43, 45, 47 TEETH BLACK/ BLUE/ RED/ GREEN/ ORANGE - INNER Ø 75 - SPROCKET CENTRE TO CENTRE DISTANCE 92

N° CA16R+TEETH-COLOR (FACTORY-BIGY)

€ 39



**PROTECTION PIGNON SORTIE BOÎTE (VIS & ENTRETOISES INCLUSES)**  
COUNTERSHAFT SPROCKET GUARD (SCREWS & SPACERS INCLUDED)

- 01 N° YC110-253BK (PILOT - FACTORY)
- 02 N° YC110-251BK (START)
- 03 N° YC110-1803-BK (ELECTRIC START ENGINE) (START SE 88/ START SE 125/ PILOT 150 E/ BIGY 150 FACTORY E)
- 04 N° YC110-1803-02-BK (LITE /START 125/PILOT 125/BIGY125-150/BIGY190 DAYTONA) € 15



**CLÉ À BOUGIE**  
SPARK PLUG REMOVAL TOOL

01 N° CB € 6

**ARRACHE VOLANT 3 EN 1**  
**ADAPTABLE SUR TOUS LES MOTEURS DE MINI**  
FLYWHEEL REMOVER 3 IN 1  
SUITABLE FOR ALL MINI BIKES ENGINES

02 N° ARRACHE-1 € 15

**OUTIL POUR DÉMONTER NOIX EMBRAYAGE ET ÉPURATEUR**  
CLUTCH TOOL

03 N° OUTIL € 15

**DÉRIVE CHÂÎNE PROFESSIONNEL**  
PROFESSIONAL CHAIN TOOL

04 N° DERIVE-1 € 25

**CLÉ À RAYONS**  
NIPPLE WRENCH

**NEW**  
**2023**

05 N° CLEARAYON-02 € 7

**JEU DE CALES MOTEUR**  
SET OF ENGINE ADJUSTMENT GAUGES

06 N° JCM-1 € 7

**CONTRÔLEUR DIGITAL DE PRESSION DE PNEU**  
DIGITAL TIRE PRESSURE GAUGE

07 N° CDP € 16

**DÉMONTE PNEU EN CUILLÈRE**  
SPOON TIRE LEVER

08 N° DEMONT-1 € 12

**OUTIL RÉGLAGE SOUPAPES**  
VALVE ADJUSTMENT TOOL/ WRENCH

11 N° YC110-2410-01 € 9

**FREIN FILET - ROUGE : FORT/ BLEU : MOYEN**  
THREADLOCKER - RED: STRONG/ BLUE: MEDIUM

09 N° FF271 (STRONG/ FORT)  
10 N° FF242 (MEDIUM/ MOYEN)

€ 16





**KIT DÉPART ENGI®**  
ENGI® LAUNCH CONTROL

N° ENGIHKF-BK

€ 59



**BAGUE/ JOINT SPI/ CACHE POUSSIÈRE FOURCHE**  
FORK RING/ OIL SEAL/ DUST COVER

- 01 N° EF03-0027 (INFERIEURE/ LOWER) € 12
- 02 N° EF03-0005 (SUPERIEURE/ UPPER) € 12
- 03 N° EF03-0009-01 (ENGI®) € 9
- 04 N° EF03-0011-01 (ENGI®) € 12  
(VENDU À L'UNITÉ/ SELL BY UNIT)



**FOURCHE ENGI® RÉGLABLE COMPRESSION DÉTENTE AVEC CORPUS ALUMINIUM ET TRAITEMENT DU TUBE INF.**  
ENGI® FORK WITH ADJUSTABLE COMPRESSION & REBOUND

N° ENGI2-800-GY (800mm)

€ 649



**FOURCHE ENGI® RÉGLABLE COMPRESSION DÉTENTE**  
ENGI® FORK WITH ADJUSTABLE COMPRESSION & REBOUND

N° ENGI2-735-BK (735mm)

€ 549



**OUTIL ASSEMBLAGE JOINT SPY ENGI®**  
ENGI® OIL SEAL ASSEMBLY TOOL

01 N° ENGI-OST € 79

**OUTIL CLÉ EN T ENGI®**  
ENGI® T-HANDLE WRENCH TOOL

02 N° ENGI-PDR € 59





**AMORTISSEUR ENGI® RÉGLABLE DÉTENTE**  
 ENGI® SHOCK ABSORBER ADJUSTABLE REBOUND

- |  |       |
|--|-------|
| N° YC110-0404-65 (270mm START)                     | € 219 |
| N° YC110-0404-66 (310mm PILOT 2013-19/ SM 2013-23) | € 279 |
| N° YC110-0404-61 (330mm SP2/ PILOT 20-23)          | € 279 |
| N° YC110-0404-63 (335mm SP3)                       | € 279 |
| N° YC110-0404-69 (355mm BIGY)                      | € 299 |



**KIT RÉFECTION INTERIEUR AMORTISSEUR**  
 ENGI® SHOCK INTERNAL REPAIR KIT

N° ES01-000B

€ 69



**KIT RÉFECTION ENTRETOISE AXE AMORTISSEUR**  
 ENGI® SHOCK SPACER KIT

N° ES01-000C

€ 25



**FACTORY**

**SPECIAL PARTS  
YCF RACING**

01



- 01 **KIT ROUE SUPERMOTO YCF/ YCF SUPERMOTO WHEEL SET** PAGE 95  
N° YC110-0626-01-BK
- 02 **PROTÈGE LEVIER TYPE MOTO GP/ MOTOGP STYLE LEVER PROTECTION** PAGE 74  
N° YC110-14-072BK
- 03 **POIGNÉE CAOUTCHOUC/ RUBBER GRIPS** PAGE 77  
N° PPC011+COLOR
- 04 **MÂTRE CYLINDRE FREIN AVANT/ FRONT BRAKE MASTER CYLINDER** PAGE 84  
N° YC110-0507-01
- 05 **GUIDON/ HANDLEBAR** PAGE 75  
N° GALOW+COLOR

**PIECES  
USINES  
CNC  
ALUMINIUM  
MULTICOLORES**

**MULTICOLOR  
FACTORY  
CNC  
ALUMINIUM  
PARTS**



# PIECES RACING SUPERMOTARD SUPERMOTARD RACING PARTS

**FACTORY**  
SPECIAL PARTS  
YCF RACING



01

**01 BÉQUILLE ROUE ARRIÈRE/ REAR STAND**  
N° STAND1MOTO-04

PAGE 57

**02 VALVE PRISE AIR/ FUEL VENT VALVE**  
N° YC125-0704+COLOR

PAGE 83

**03 DONUTS/ GRIP DONUTS**  
N° DONUTZ-02+COLOR

PAGE 77

**04 PASSE DURITE FREIN AVANT/ OIL STEEL LINE RETAINER**  
N° YC110-0403-06+COLOR

PAGE 72



- |  |          |
|--|----------|
| <b>01 DISQUE FREIN AVANT FLOTTANT/ SEMI FLOATING BRAKE ROTOR</b> | PAGE 90  |
| N° YC110-0613-01-BK  |          |
| <b>02 ÉTRIER FREIN AVANT/ BRAKE CALIPER</b>                      | PAGE 84  |
| N° YC110-0502-06-BK  |          |
| <b>03 DIABOLO/ REAR SPOOL</b>                                    | PAGE 92  |
| N° KRS-COLOR   |          |
| <b>04 COURONNE ALUMINIUM/ ALUMINUM SPROCKET</b>                  | PAGE 107 |
| N° CA16R+COULEUR   |          |
| <b>05 CHAÎNE/ CHAIN</b>  | PAGE 106 |
| N° 420DX-110T  |          |
| <b>06 TENDEUR CHAÎNE ALUMINIUM / ALUMINUM AXLE BLOCK</b>         | PAGE 107 |
| N° TC12+ COLOR   |          |



- |  |          |
|--|----------|
| <b>07 RADIATEUR HUILE/ OIL COOLER</b>                      | PAGE 131 |
| N° YC110-2306  |          |
| <b>08 SABOT RÉCUPERATEUR HUILE/ RACE BELLY PAN</b>         | PAGE 104 |
| N° YC110-202-03-COLOR                                      |          |
| <b>09 BOUCHON DE VALVE/ VALVE CAP SET</b>                  | PAGE 102 |
| N° TVC-COLOR   |          |
| <b>10 BOCAL RÉCUPERATEUR ESSENCE/ FUEL RECUPERATOR KIT</b> | PAGE 105 |
| N° KS3   |          |



**FACTORY**  
 SPECIAL PARTS  
 YCF RACING

- |   |          |
|---|----------|
| <b>01</b> CAPOT MÂTRE CYLINDRE FREIN ARRIÈRE/ REAR BRAKE RESERVOIR COVER<br>N° RBRC01+COLOR   | PAGE 91  |
| <b>02</b> CHAPE MÂTRE CYLINDRE FREIN ARRIÈRE/ REAR BRAKE CLEVIS<br>N° EMC01+COLOR   | PAGE 88  |
| <b>03</b> PÉDALE FREIN / BRAKE PEDAL<br>N° YC110-219-03-BK  | PAGE 88  |
| <b>04</b> EMBOUT PÉDALE FREIN/ REAR BRAKE LEVER TIPS<br>N° YC110-1223-02+COLOR  | PAGE 88  |
| <b>05</b> REPOSE PIED ALUMINIUM/ ALUMINUM FOOT PEGS<br>N° RPALU+COLOR   | PAGE 104 |
| <b>06</b> JAUGE HUILE/ OIL DIPSTICK<br>N° JH01+COLOR  | PAGE 131 |
| <b>07</b> COUVRE FILTRE HUILE/ OIL FILTER COVER<br>N° OFCDAYT-COLOR   | PAGE 134 |
| <b>08</b> LIGNE ÉCHAPPEMENT RACING DOUBLE/ COMPLETE RACING EXHAUST TWIN<br>N° YC110-139-08-BK   | PAGE 129 |
| <b>09</b> PNEU/ TIRES<br>N° 120/70-12K702   | PAGE 103 |
| <b>10</b> ÉTRIER FREIN ARRIÈRE/ REAR BRAKE CALIPER<br>N° YC110-1201-06-BK   | PAGE 84  |
| <b>11</b> AMORTISSEUR DNM À BONBONNE RÉGLABLE COMPRESSION/ DÉTENTE<br>DNM PIGGY BAG SHOCK ABSORBER ADJUSTABLE COMPRESSION & REBOUND<br>N° YC110-0404-59 | PAGE 94  |



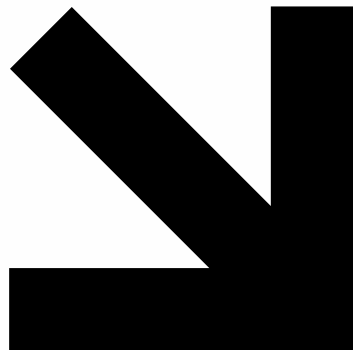
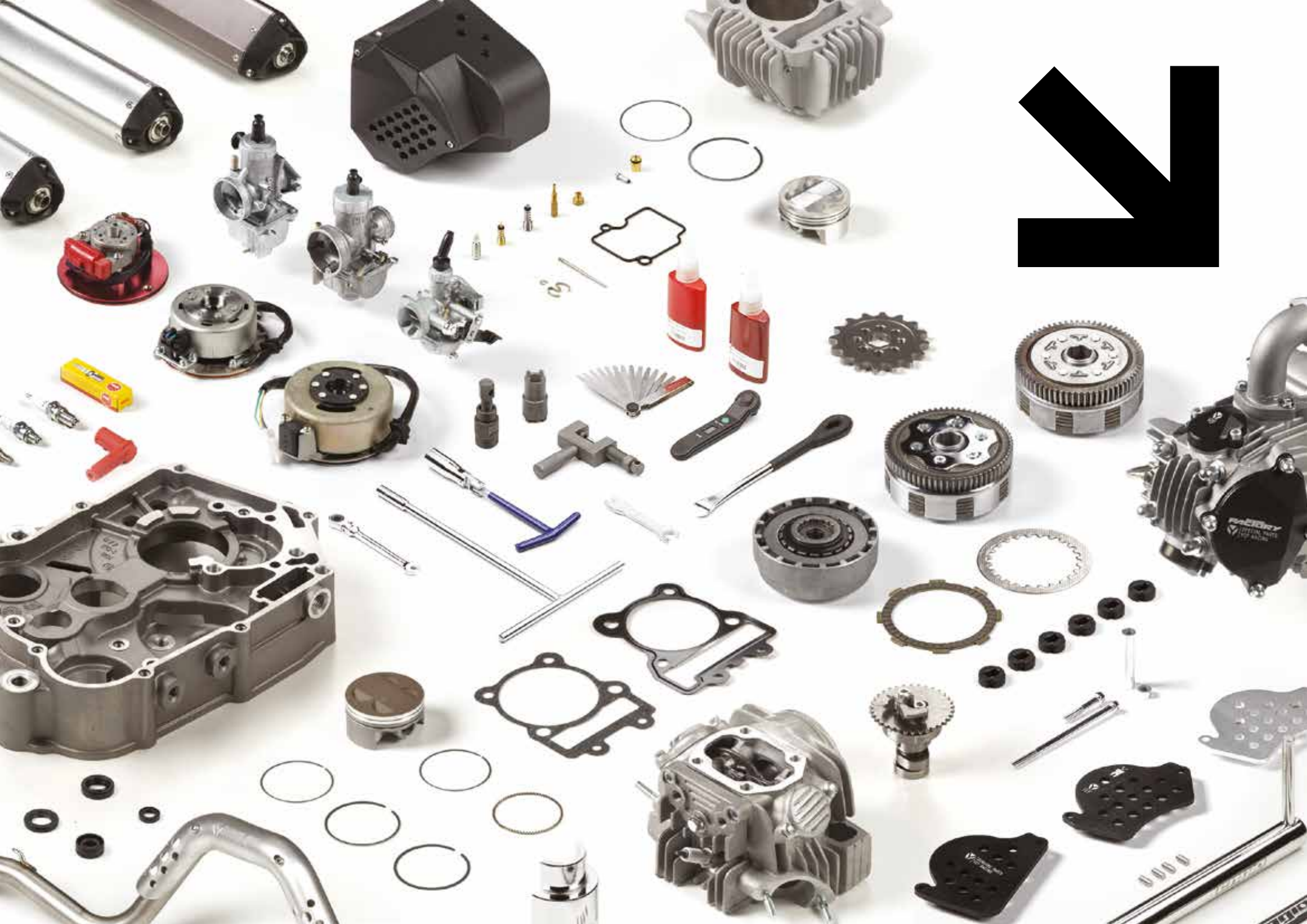

# ENGINE PARTS

## PIÈCES MOTEUR

<b>MOTEURS DAYTONA®/ DAYTONA® ENGINES</b>	118
<b>MOTEURS/ ENGINES</b>	119
<b>KITS MOTEUR/ ENGINE KITS</b>	120
<b>EMBRAYAGE/ CLUTCH</b>	123
<b>CARBURATEURS/ CARBURETORS</b>	125
<b>FILTRES À AIR/ AIR FILTERS</b>	127
<b>ÉCHAPPEMENTS/ EXHAUSTS</b>	128
<b>FILTRES &amp; RADIATEURS/ FILTERS &amp; COOLERS</b>	131
<b>ALLUMAGE/ IGNITION</b>	132
<b>PIÈCES RACING DAYTONA®/ DAYTONA® RACING PARTS</b>	134
<b>PIÈCES D'ORIGINE DAYTONA®/ DAYTONA® PARTS</b>	135



# MOTEURS ENGINES

# DAYTONA®

DAYTONA® EST UNE SOCIÉTÉ JAPONNAISE SPÉCIALISÉE DANS LE DÉVELOPPEMENT ET LA FABRICATION DE PIÈCES HAUTE PERFORMANCE MOTOS DEPUIS 1972. L'ENTREPRISE EST UN LEADER INTERNATIONAL DE L'INDUSTRIE DES PIÈCES RACING.  
(DÉTAIL DES PIÈCES À PARTIR DE LA PAGE 130)

DAYTONA® IS A JAPANESE COMPANY SPECIALIZED IN HIGH PERFORMANCE PARTS. THEY HAVE BEEN A LEADER IN MOTORCYCLE INDUSTRY SINCE 1972. THEY PROVIDE ORIGINAL AND RACING PARTS FOR MOTORCYCLE TO THE INTERNATIONAL MARKETPLACE.  
(SEE PARTS DETAILS FROM PAGE 130)

**CARTER RENFORCÉ**  
REINFORCED CRANKCASE



FEATURING

**DÉCOMPRESSEUR AUTOMATIQUE**  
DECOMPRESSION SYSTEM



DAYTONA



## ANIMA® 2.0 MX

**MOTEURS DAYTONA® ANIMA® 2,0**

DAYTONA® ANIMA® 2.0 ENGINES

N° 88026 (150cc FSM)	€ 1099
N° 87615 (190cc, 4 SPEEDS)	€ 1199
N° 88025 (ANIMA® 160cc, FSM, 4 SPEEDS)	€ 1199
N° 89734 (190cc, 5 SPEEDS)	€ 1149



**MOTEUR DAYTONA® 190cc FE DÉMARREUR ÉLECTRIQUE 5 VITESSES**

DAYTONA® 190cc FE ENGINE ELECTRIC START 5 SPEEDS

N° 88392	€ 1149
----------	--------

# ZONGSHEN



**MOTEUR ZONGSHEN® FIDDY**

ZONGSHEN® FIDDY ENGINE

N° MOTEUR110-G	€ 449
N° MOTEUR125-G	€ 599
N° MOTEUR155-G	€ 749



**MOTEUR 50 YCF 2012-2020 AUTOMATIC**  
YCF 50 ENGINE 2012-2020 AUTOMATIC

01 N° MOTEUR50-01-GY € 429

**MOTEUR 125 À DÉMARREUR**  
125 4 SPEED SEMI-AUTOMATIC ENGINE ELECTRIC START

02 N° MOTEUR125SELE-01 € 499

**MOTEUR 88 À DÉMARREUR**  
88 4 SPEED SEMI-AUTOMATIC ENGINE ELECTRIC START

03 N° MOTEUR88ELE-02 € 449

**MOTEUR 88 4 VITESSES SEMI-AUTOMATIC**  
88 4 SPEED SEMI-AUTOMATIC ENGINE

04 N° MOTEUR88 € 399

**MOTEUR 125 POINT MORT**  
125 NEUTRAL ENGINE

05 N° MOTEUR125P € 399

**MOTEUR 125 4 VITESSES SEMI-AUTOMATIC**  
125 4 SPEED SEMI-AUTOMATIC ENGINE

06 N° MOTEUR125SEMI € 429

**MOTEUR 150 TYPE KLX**  
150 ENGINE TYPE KLX

07 N° MOTEUR150-2 € 749

**MOTEUR 150-3**  
150-3 ENGINE

08 N° MOTEUR150-3 € 579

**MOTEUR 150 TYPE CRF**  
150 ENGINE TYPE CRF

09 N° MOTEUR150-5 € 679

**MOTEUR 150 YX DÉMARREUR ÉLECTRIQUE**  
150 YX ENGINE ELECTRIC START

10 N° MOTEUR150-3E € 599



# **KITS MOTEUR & PIÈCES** **ENGINE KITS & PARTS**



**CHAÎNE DE DISTRIBUTION**  
TIMING SPROCKET

N° D00F012 (84 MAILLONS POUR 125cc POINT MORT ET SEMI-AUTOMATIQUE/ 84 TEETHS FOR 125cc NEUTRAL START AND SEMI-AUTOMATIC) **€ 25**  
 N° 14350 (88 MAILLONS POUR 140cc lifan/ 88 TEETHS FOR 125cc lifan) **€ 25**  
 N° 14350/152FMI (90 MAILLONS POUR 125/ 140/ 150 CRF/ 90 TEETHS FOR 125/ 140/ 150 CRF TYPE) **€ 25**  
 N° 210F012 (POUR YX 150/ 160 TYPE KLX/ FOR 150/ 160 YX KLX TYPE) **€ 39**



**NEW 2023**

**BOUCHON CARTER ALUMAGE YCF CNC**  
**NOIR/ BLEU/ ROUGE/ VERT/ ORANGE**

ALUMINIUM CAP BIG VIEW HOLE FOR YCF COVER  
BLACK/ BLUE/ RED/ GREEN/ ORANGE

N° YC110-2014-01-COLOR

**€ 9**



**CARTER D'ALLUMAGE POUR DÉMARREUR ÉLECTRIQUE**  
IGNITION COVER ELECTRIC START

01 N° 12301-D083-000189 **€ 39**  
 02 N° 90204-D083-000 **€ 6**

**NEW 2023**



**NOUVEAU CARTER D'ALLUMAGE YCF (Pour démarrage au kick)**  
NEW YCF IGNITION COVER (kickstart only)

01 N° YC110-2004-01-GY (GRIS/GREY) **€ 49**  
 02 N° YC110-2004-01-BK (NOIR/BLACK) **€ 49**  
 03 N° YC110-2004-01-MG (MAGNESIUM) **€ 49**



#### CARTER D'ALLUMAGE

IGNITION COVER

- 01 N° 11411/152FMH (CARTER D'ALLUMAGE/ IGNITION COVER) € 37
- 02 N° 11411/152FMH-MG (CARTER D'ALLUMAGE/ IGNITION COVER) € 45
- 03 N° 11411/152FMH-BK (CARTER D'ALLUMAGE/ IGNITION COVER) € 45
- 04 N° 11419/152FMH (JOINT CARTER ALLUMAGE/ IGNITION COVER GASKET) € 7
- 05 N° A00-8-1(CARTER ALLUMAGE LITE 88/125) € 37



#### CHAÎNE DE DÉMARREUR

STARTER CHAIN

- 01 N° 2141B-IA29-0000 POUR MOTEUR/ FOR ENGINE 88-125 SE € 12
- 02 N° 100061493 POUR MOTEUR/ FOR ENGINE 190 ZONGSHEN® € 12



#### KIT PISTON

PISTON KIT

- N° KPC/44-13 (YCF 50A) € 55
- N° KPC/47-13 (88 CC Ø 46,5 AXE 13) € 55
- N° KPC/52,5-13 (88/107/120/125 CC Ø 52,5 AXE 13) € 55
- N° KPC/52,5-14 (120/125 CC Ø 52,5 AXE 14) € 55
- N° KPC/54-14 (120/125 CC Ø 54 AXE 14) € 55
- N° KPC/55-15 (140 LIFAN Ø 55 AXE 15) € 55
- N° KPC/56-13 (140/150 YX TYPE CRF Ø 56 AXE 13) € 55
- N° KPC/56,5-15 (150 LIFAN Ø 56,5 AXE 15) € 55
- N° KPC/60-13 (150-160 YX TYPE KLX Ø 60 AXE 13) € 59

#### JEU DE SEGMENTS SEUL

PISTON RINGS SET ONLY

- N° 13300F (88 CC Ø 46,5) € 20
- N° 13300/152FMI (107-125 CC Ø 52,5) € 20
- N° 13300/152FMH (125-138 CC Ø 54) € 20
- N° 13300 (140 CC Ø 55) € 20
- N° 208J013 (140-150 CC Ø 56) € 19
- N° 210J013 (150 CC Ø 60) € 19

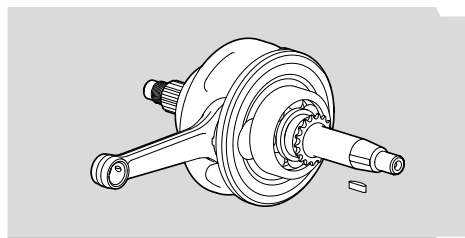

#### VILEBREQUIN

CRANKSHAFT

- N° 13100/152FMI (125 LIFAN AXE PISTON 14) € 99
- N° 208J000 (125/140 YX AXE PISTON 13) € 119
- N° 13100 (140 LIFAN AXE PISTON 15) € 119
- N° 216J000 (150 CRFAXE PISTON 13) € 139
- N° 2104J000 (150 KLX) € 139
- N° 2043J000 (125 POINT MORT) € 119



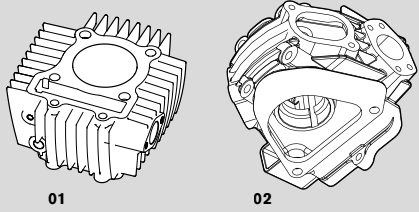

**CYLINDRES & CULASSES**  
CYLINDERS & CYLINDER HEADS

- 01 N° 12110/152FMI (125 LIFAN 52,5mm)
- 01 N° 12112 (140 LIFAN 55mm)
- 01 N° 206A038 (125 YX 52,5mm)
- 01 N° 2081A038 (140 YX 56mm)
- 01 N° 208A038 (150 YX TYPE CRF)
- 01 N° 210A038 (150 YX TYPE KLX)
- 01 N° 204A038 (125 YX 54mm) € 119
  
- 02 N° 206A000 (125 YX)
- 02 N° 208A000 (140/150 YX TYPE CRF)
- 02 N° 210A000 (150/160 YX TYPE KLX) € 209

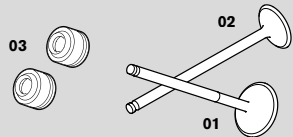

**SOUPAPE D'ADMISSION**  
INLET VALVE

- 01 N° 206F045 (125 YX Ø 24)
- 01 N° 14710/152FMI (125, 140, 150 Ø 27)
- 01 N° 210F045 (KLX) € 19
  
- 01 N° 221F045 (KLX 4V) € 39

**SOUPAPE D'ÉCHAPEMENT**  
EXHAUST VALVE

- 02 N° 206F039 (125 YX Ø 21)
- 02 N° 14720/152FMI (125, 140, 150 Ø 23)
- 02 N° 210F039 (KLX) € 19
  
- 02 N° 221F039 (KLX 4V) € 39

**JOINT QUEUE SOUPAPE**  
VALVE STEM SEAL

- 03 N° 14730/152FMH € 5

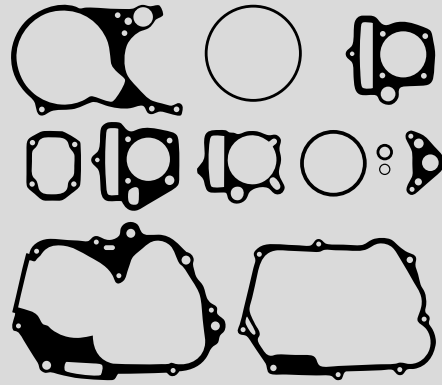

**POCHETTE JOINTS COMPLÈTE**  
COMPLETE GASKET SET

- N° PJCM50 (50S YCF 2010-2011) € 39
- N° PJCM50-2 (50A YCF 2012-2022) € 39
- N° PJCM88 (88 CC) € 39
- N° PJCMSE (START F88SE/ F125SE) € 39
- N° PJCM125 (125 CC) € 49
- N° PJCM140 (140 CC) € 39
- N° PJCM150CRF (150 CC) € 39
- N° PJCM150KLX (150 CC TYPE KLX) € 45
- N° PJCM150-3E (PILOT F150E 2022-23) € 45



**POCHETTE JOINTS HAUT MOTEUR**  
GASKET SET TOP END

- N° PJHM50 (50S YCF 2010-2011) € 19
- N° PJHM50-2 (50A YCF 2012-2022) € 19
- N° PJHM88 (88 CC) € 19
- N° PJHM125 (125 CC) € 29
- N° PJHM140 (140 CC) € 25
- N° PJHM150CRF (150 CC) € 25
- N° PJHM150KLX (150 CC TYPE KLX) € 25
- N° PJHM150-3E (PILOT F150E 2022-23) € 25

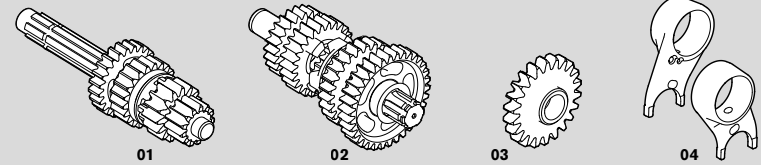

**ARBRE BOÎTE PRIMAIRE COMPLET Ø 12 CÔTÉ ALLUMAGE Ø 14 CÔTÉ EMBR. LIFAN LONG. 155mm/ YX LONG. 153,5mm**  
COMPLETE MAIN BOX SHAFT Ø 12 IGNITION SIDE & Ø 14 CLUTCH SIDE LIFAN LENGTH 155mm/ YX LENGTH 153,5mm

- 01 N° 23600/152FMH (LIFAN)
- 01 N° E13K030 (YX)
- 01 N° A00K030 (88/ 125 SEMI-AUTO ET 125 POINT MORT) € 49

**ARBRE BOÎTE SECONDAIRE COMPLET Ø 17 CÔTÉ PSB LIFAN Ø 14 CÔTÉ ALLUMAGE/ YX Ø 15 CÔTÉ ALLUMAGE**  
COMPLETE SECONDARY BOX SHAFT Ø 17 PSB SIDE LIFAN Ø 14 IGNITION SIDE/ YX Ø 15 IGNITION SIDE

- 02 N° 23700/152FMH (LIFAN)
- 02 N° E13K040 (YX)
- 01 N° A00K040 (88/ 125 SEMI-AUTO ET 125 POINT MORT) € 49

**PIGNON INTERMÉDIAIRE EMBRAYAGE**  
INTERMEDIATE CLUTCH SPROCKET

- 03 N° 208-12-23N (YX : ÉPAISSEUR/ THICKNESS 14mm) € 12

**JEU DE FOURCHETTES DE BOÎTE RENFORCÉE**  
REINFORCED GEARBOX FORK

- 04 N° FBR € 35

# EMBRAYAGE CLUTCH



**EMBRAYAGE COMPLET DÉMARRAGE AU POINT MORT  
START 2012-13**  
COMPLETE CLUTCH NEUTRAL START  
START 2012-13

N° EC € 65



**EMBRAYAGE COMPLET 88/125 SEMI-AUTO**  
COMPLETE CLUTCH 88/125 SEMI-AUTO

N° 21100L € 79



**EMBRAYAGE COMPLET POUR DÉMARRAGE EN PRISE**  
COMPLETE CLUTCH FOR KICKSTARTER ENGINE

N° 22100/152FMH € 82



**COURONNE D'EMBRAYAGE 88/125 SEMI-AUTO**  
CLUTCH SPROCKET 88/125 SEMI-AUTO

N° 22610L € 20



**DISQUE D'EMBRAYAGE YX**  
YX CLUTCH PLATE

01 N° 22330/152FMH (GARNI/ FRICTION) € 6  
02 N° 22341/152FMH (LISSE/ SMOOTH) € 6



**DEMI CARTER EMBRAYAGE 88/ 125**  
HALF CLUTCH COVER 88/ 125

N° RCSC-BK € 25





**JOINTS DE CARTER D'EMBRAYAGE**  
ENGINE CLUTCH COVER GASKET

- 01 N° E041B002 (START/ PILOT 125) € 7  
02 N° 11319/152FMH (125 - 140 - 150CRF) € 7



**JOINT SPY SÉLECTEUR**  
OIL SEAL SHAFT

- 01 N° 24190/152FMH € 7

**JOINT SPY KICK**  
KICKSTARTER OIL SEAL

- 02 N° F001C015 (KLX: 16X28X7)  
02 N° F05C085 (CRF: 16X24X5)  
02 N° 27190/152FMH (Ø 13mm) € 6

**JOINT SPY PSB**  
OIL SEAL FOR COUNTERSHAFT SPROCKET

- 03 N° 23790/152FMI (Ø 20 - 20/30/4.5)  
03 N° 23790/152FMH (Ø 17 - 17/29/5) € 6

**JOINT SPY TIGE COMMANDE EMBRAYAGE**  
CLUTCH CONTROL OIL SEAL

- 04 N° 22840/152FMH € 5

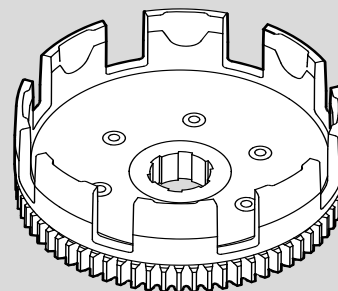

**CLOCHE D'EMBRAYAGE**  
CLUTCH BELL

- N° 22110/152FMH € 49

**PIGNON DE KICK**  
KICKSTARTER SPROCKET YX

- 02 N° 27151/152FMH (LIFAN)  
02 N° 208K025 (YX) € 15

**PIGNON CLOCHE EMBRAYAGE**  
CLUTCH BELL SPROCKET

- 03 N° 27231/152FMH (LIFAN)  
03 N° 208-12-25 (YX) € 15

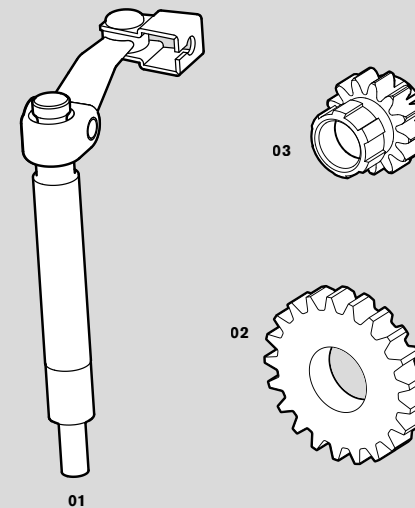

**TIGE COMMANDE EMBRAYAGE**  
PUSH ROD

- 01 N° 22810/152FMH € 15



**ARBRE À CAME RACING POUR MOTEUR 140/150 YX**  
(PILOT/BIGY 150)  
RACING CAMSHAFT FOR YX 140/150 ENGINE  
(PILOT/BIGY 150)

- N° Z40 € 59



# CARBURATEURS CARBURETORS

**NIBBI**



## CARBURATEUR NIBBI

NIBBI CARBURETOR

- 01 N° YC50-20-31 POUR MOTEUR 50cc € 59
- 02 PE18FL POUR MOTEUR 88cc € 75
- 03 N° PE19FL POUR MOTEUR 125/150cc € 75
- N° PE24SP (SM125/SM150) € 75
- 04 N° PE28SP POUR MOTEUR 190cc € 119
- 05 N° NIBBI34 € 169

**GICLEUR NIBBI CARBURATEUR PE GICLEUR PRINCIPAL / MAIN JET 88/90/92/95/98/100/102/105/108/110/112/115/118/120/122/125/128/130/132/135**

- 06 N° LK-PE+TAILLE € 7

**GICLEUR NIBBI CARBURATEUR PWK GICLEUR PRINCIPAL / MAIN JET 98/100/102/105/108/110/112/115/118/120/122/125/128/130/132/135/138/140/142/145/148**

- 07 N° LK-PWK+TAILLE € 7

**GICLEUR NIBBI CARBURATEUR PZ GICLEUR PRINCIPAL / MAIN JET 70/72/78/80/82/85/90/95/100**

- 08 N° LK-PZ+TAILLE € 7

**GICLEUR NIBBI CARBURATEUR PE/PWK GICLEUR RALENTI / SLOW JET 32/35/38/42/45/48**

- 09 N° LK-FLK+TAILLE € 7

**GICLEUR NIBBI CARBURATEUR PZ GICLEUR RALENTI / SLOW JET 32/35/38**

- 10 N° LK-FLKZ+TAILLE € 7

**NIBBI**



## KIT CARBURATEUR NIBBI 24

KIT CARBURETOR NIBBI 24

N° NIBBI24

€ 119

**KEIHIN**



## CARBURATEUR KEIHIN® PE28mm

PE28mm KEIHIN® CARBURETOR

N° 85707

€ 219

**MIKUNI**



## VIS DE CUVE MIKUNI®

MIKUNI® TANK SCREW

01 N° 16007L

€ 7

## VIS RICHESSE + RESSORT MIKUNI®

MIKUNI® NEEDLE VALVE + SPRING

02 N° 16005L

€ 7

## VIS RALENTI + RESSORT MIKUNI®

MIKUNI® IDLE SCREW + SPRING

03 N° 16006L

€ 7

## GICLEUR RALENTI MIKUNI® 10/ 15/ 17,5/ 20/ 22,5/ 25

MIKUNI® SLOW JET

04 N° GICLEUR+SIZE

€ 7

**GICLEUR PRINCIPAL MIKUNI® 85/ 90/ 92,5/ 95/ 97,5/ 100/ 102,5/ 105/ 107,5/ 110/ 115/ 120**

MIKUNI® MAIN JET

05 N° GICLEUR+SIZE

€ 7

## POINTEAU CARBURATEUR

CARBURETOR FLOAT NEEDLE

06 N° FLON-50A (YCF50A)

07 N° FLON-CARBU22 (MIKUNI® 22)

08 N° 16008L (MIKUNI® 26)

€ 12

## AIGUILLE CARBURATEUR MIKUNI®

MIKUNI® CARBURETOR NEEDLE

09 N° 16004L

€ 12

## JOINT CUVE CARBURATEUR

CARBURETOR FLOAT BOWL GASKET

10 N° 16010L (MIKUNI® 26)

11 N° SEAL-CARBU22 (MIKUNI® 22)

12 N° SEAL-PE28 (KEIHIN® PE28)

13 N° SEAL-50A (YCF 50A)

€ 5



**PIPE ADMISSION DAYTONA®**  
DAYTONA® INLET PIPE

- 01 № 86404 (ANIMA) € 25
- № 84387 (DT) € 29

**PIPE ADMISSION SANS BOÎTE À AIR**  
INLET PIPE WITHOUT AIRBOX

- 02 № 17311 € 16

**PIPE ADMISSION POUR BOÎTE À AIR**  
INLET PIPE FOR AIRBOX

- 03 № 17311-2 (POUR/ FOR FACTORY SPII) € 19
- 03 № 17311-4 (POUR/ FOR PILOT 125) € 19
- 03 № 17311-5 (POUR/ FOR PILOT 150) € 19
- 03 № 17311-6 (POUR/ FOR PE28) € 19
- 03 № 17311-3 (POUR/ FOR FACTORY SPIII) € 19

**JOINT PAPIER PIPE ADMISSION**  
INLET PIPE PAPER GASKET

- 04 № 17332/152FMH01 (ENTRE LA PIPE D'ADMISSION ET LE CARBURATEUR/ BETWEEN INLET PIPE AND CARBURETOR) € 2,50
- 04 № 17332 (ENTRE LA CULASSE ET LA PIPE D'ADMISSION/ BETWEEN CYLINDER HEAD AND INLET PIPE) € 2,50

**CALE PLASTIQUE PIPE ADMISSION**  
INLET PIPE PLASTIC HOLDER

- 05 № 17331/152FMH € 6



FOR 50 ONLY



**STARTER AU GUIDON POUR YCF50A**  
CHOKE LEVER FOR YCF50A

- 01 № YC50-0142-01 € 19



**MANCHON SOUPLE**  
FLEXIBLE SLEEVE

- 01 № 17315 (VM 24) € 29
- 02 № 46758 (POUR/ FOR DAYTONA®) € 35





# FILTRES À AIR AIR FILTERS



**SURFILTRE À AIR (VENDU SANS FILTRE À AIR)**  
AIR FILTER PROTECTION (SELL WITHOUT AIR FILTER)

N° K130K (POUR FILTRE ORIGINE YCF/ FOR YCF ORIGINAL AIR FILTER)  
N° K386K (POUR/ FOR TWIN AIR)

€ 19



**CAGE DE FILTRE À AIR**  
AIR FILTER CAGE

01 N° YC110-08-012  
02 N° YC110-08-013

€ 10

€ 10

**MANCHON DE BOÎTE À AIR YCF**  
YCF AIRBOX SLEEVE

03 N° YC110-08-0171 (Ø 49 POUR/ FOR KEHIN® PE28)  
03 N° YC110-08-017 (Ø 40)  
03 N° YC110-08-0173 (PILOT 125 2015-2020)  
03 N° YC110-08-0174 (PILOT 150 2016-2020/ SM150 2016-2020)  
03 N° YC110-0823-02 (BIGY 125 2021-23)  
03 N° YC110-0823-03 (SP3 2021-22 / BIGY 150 - 190 2021-23)  
03 N° YC110-0823-04 (PILOT 125 2021-23)  
03 N° YC110-0823-07 (PILOT 150 2021-23)

€ 10



01 02 03

**FILTRE À AIR MOUSSE**  
FOAM AIR FILTER

01 N° TA-158430 (POUR/FOR AIR BOX PILOT/ FACTORY/ BIGY)  
02 N° TA-158432 (Ø 40mm POUR/ FOR MIKUNI® 26mm)  
03 N° TA-158431 (Ø 50mm POUR/ FOR KEIHIN® 28mm)

€ 22

€ 27

€ 27



03

02

**⚠ PIPE ADMISSION ADÉQUATE, VOIR PAGE 126**  
SUITABLE INLET PIPE, CHECK PAGE 126

**BOÎTE À AIR**  
AIRBOX

01 N° YC110-0801-07 (POUR/ FOR PILOT 125 & 150, 2015-23)  
02 N° YC110-08-02 (POUR/ FOR FACTORY 2012-23)  
03 N° YC110-0801-09 (POUR/ FOR LITE/ START)

€ 49



**FILTRE À AIR MOUSSE**  
FOAM AIR FILTER

01 N° YC110-0802-03 (POUR/ FOR CARBU 22 mm)  
(POUR FOR LITE/ START 88) € 22  
02 N° YC110-0802-10 (POUR/ FOR CARBU 26 MIKUNI/  
NIBBI PE19FL/ PE24SP)(POUR FOR LITE/ START 125/  
SM 125/150) € 22  
03 N° YC110-0802-05 (POUR/ FOR CARBU KEIHIN/  
NIBBI PE 28 mm) € 24



**FILTRE À AIR EN MOUSSE POUR BOÎTE À AIR**  
FOAM AIR FILTER FOR AIR BOX

N° YC110-0817-03-BL  
(PILOT 2016-22/ FACTORY 2012-23/ BIGY) € 17

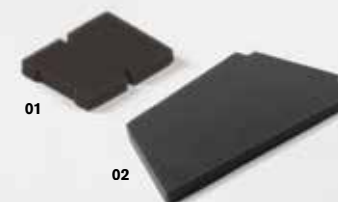

01

02

**FILTRE À AIR EN MOUSSE POUR BOÎTE À AIR**  
FOAM AIR FILTER FOR AIR BOX

01 N° YC50-0802 (POUR/ FOR YCF 50) € 7  
02 N° YC110-0817-02 (POUR/ FOR LITE/ START) € 13

# ÉCHAPPEMENTS EXHAUSTS



**SPECIAL PARTS  
YCF RACING**

**LAINES DE ROCHE POUR SILENCIEUX**  
MUFFLER ROCKWOOL FOR NOISE REDUCTION

**01** N° LR1 € 12

**BRIDE DE POT POUR SILENCIEUX**  
MUFFLER SPARK ARRESTOR

**02** N° YC110-13-30 € 30

**JOINT DE POT**  
EXHAUST SEAL

**03** N° 18291/152FMH € 2

**EMBOUIT DE POT 88/RS/RSP/SM 2011-2022**  
EXHAUST END FOR 88/RS/RSP/SM 2011-2022

**04** N° YC110-13-32 € 19

**RESSORT DE POT AVEC CAOUTCHOUC**  
EXHAUST SPRING WITH RUBBER

**05** N° YC110-13-21 € 5

**EMBOUIT SILENCIEUX POUR LAVAGE MOTO**  
WASH MUFFLER PLUG

**06** N° EEP-BL € 5

**BRIDE DE POT**  
SPARK ARRESTOR

**07** N° BP30BLACK (Ø 30) € 19

**EMBOUIT DE POT CRD®**  
CRD® EXHAUST END

**08** N° YC110-13-31 € 19



**ATTACHE SILENCIEUX OVALE (88, RS, RSP, SM 2011-22)**  
OVAL MUFFLER CLAMP (88, RS, RSP, SM 2011-22)

N° YC110-13-06

€ 15



# ÉCHAPPEMENTS RACING RACING EXHAUSTS



**FACTORY**  
SPECIAL PARTS  
YCF RACING

**LIGNE ÉCHAPPEMENT COMPLÈTE RACING SIMPLE**  
COMPLETE RACING EXHAUST SINGLE

N° YC110-136-07-BK (POUR/ FOR PILOT/ SM150)  
N° YC110-139-07-BK (POUR/ FOR FACTORY)  
N° YC110-140-01-BK (POUR/ FOR BIGY)

€ 299



**EMBOUT DE POT FACTORY**  
FACTORY EXHAUST END

N° YC110-13-35

€ 19



**RESSORT DE POT FACTORY**  
FACTORY EXHAUST SPRING WITH RUBBER

N° YC110-13-22

€ 5



**FACTORY**  
SPECIAL PARTS  
YCF RACING

**SILENCIEUX RACING FACTORY**  
FACTORY RACING EXHAUST

N° YC110-13014-03BK

€ 149



**FACTORY**  
SPECIAL PARTS  
YCF RACING

**ATTACHE SILENCIEUX FACTORY**  
FACTORY MUFFLER CLAMP

N° YC110-1307-03

€ 19



**FACTORY**  
SPECIAL PARTS  
YCF RACING

**LIGNE ÉCHAPPEMENT COMPLÈTE RACING DOUBLE**  
COMPLETE RACING EXHAUST TWIN

N° YC110-136-08-BK (POUR/ FOR PILOT/ SM150)  
N° YC110-139-08-BK (POUR/ FOR FACTORY)  
N° YC110-140-02-BK (POUR/ FOR BIGY)

€ 399



**COLLECTEUR RACING**  
RACING MID PIPE

N° YC110-1302-22 (PILOT) € 89  
 N° YC110-1302-13 (SP3) € 89  
 N° YC110-1308-01 (BIGY) € 89



**Y DU COLLECTEUR RACING DOUBLE**  
DOUBLE RACING MID PIPE Y

N° YC110-1302-23 (PILOT)  
 N° YC110-1302-14 (SP)  
 N° YC110-1308-03 (BIGY) € 79



**PARTIE INTERMÉDIAIRE COLLECTEUR RACING**  
RACING MID PIPE INTERMEDIATE PART

N° YC110-1302-24 (PILOT)  
 N° YC110-1302-15 (SP)  
 N° YC110-1308-02 (BIGY) € 49



**ÉCHAPPEMENT YCF ANTI-BRUIT (GAMME FACTORY)**  
SPARK ARESTOR YCF EXHAUST (FACTORY RANGE)

N° YC110-139-03 (POUR/ FOR FACTORY SP2 & SP3)  
 N° YC110-139-09 (POUR/ FOR BIGY) € 249



**COLLECTEUR ÉCHAPPEMENT FACTORY**  
FACTORY EXHAUST MID PIPE

N° YC110-13028-01 (SP3) € 119  
 N° YC110-13028-03 (BIGY 190) € 119  
 N° YC110-13028-05 (PILOT) € 119  
 N° YC110-13028-02 (SP3 DOUBLE) € 149  
 N° YC110-13028-04 (BIGY DOUBLE) € 149  
 N° YC110-13028-06 (PILOT DOUBLE) € 149



**ÉCHAPPEMENT GROS DIAMÈTRE AVEC BRIDE DE POT AMOVIBLE**  
LARGE DIAMETER EXHAUST SUPPLIED WITH REMOVABLE SPARK ARRESTOR

N° YC110-136-GY (POUR/ FOR START) € 99  
 N° YC110-136-03-GY (POUR/ FOR PILOT/ SM 150) € 99  
 N° YC110-139-10 (POUR/ FOR BIGY) € 149



**COLLECTEUR ÉCHAPPEMENT BIGY**  
BIGY EXHAUST MID PIPE

N° YC110-1302-20 (125/150 BIGY MX)  
 N° YC110-1302-26 (190 BIGY ZE)  
 N° YC110-1302-28 (150 BIGY FACTORY) € 59

# FILTRES & RADIATEURS FILTERS & COOLERS



**KIT COMPLET RADIATEUR HUILE**  
COMPLETE OIL COOLER KIT

N° YC110-2307 (DIAM 10/10 DAYTONA @/ YX150-5 (CRF))  
N° YC110-2305 (DIAM 8/10 YX150-2 (KLX)/ ZONGSHEN 155-G/ ZONGSHEN 125-G) € 95



**KIT RADIATEUR UNIVERSEL ADAPTABLE SUR TOUS LES MODÈLES**  
UNIVERSAL OIL COOLER KIT ADAPTABLE TO ALL MODELS

N° YC110-2306 (VENDU AVEC 6 DURITES/ SOLD WITH 6 HOSES) € 249



**PETITE JAUGÉ HUILE NOIRE/ BLEUE/ ROUGE/ VERTE/ ORANGE**  
LITTLE OIL DIPSTICK BLACK/ BLUE/ RED/ GREEN/ ORANGE

01 N° JH01-COLOR (SM150/ FACTORY/ BIGY FACTORY 150/190) € 19



**FILTRE À HUILE**  
OIL FILTER

01 N° 216E010 € 19  
01 N° 14210-1038-0000 (110/125/155 ZONGSHEN FIDDY RACER)  
LITE110R/ SM125/155/ PILOT 125 2022/ BIGY 125 2022 € 19



**ÉPURATEUR D'HUILE ALLÉGÉ**  
FLYWHEEL

02 N° 208G082 € 25



**DURITE HUILE RADIATEUR**  
OIL COOLER HOSE

N° YC110-23-01 (2007)  
N° YC110-23-013 (L=400MM)  
N° YC110-23-014 (L=285MM/ Ø=8/8)  
N° YC110-23-015 (L=260MM/ Ø=8/8)  
N° YC110-23-016 (L=125MM/ Ø=10/10)  
N° YC110-23-017 (L=290MM/ Ø=10/10)  
N° YC110-23-0003 (L=110MM/ Ø=10/8)  
N° YC110-23-02 (2007)  
N° YC110-23-022 (L=490MM)  
N° YC110-23-023 (L=395MM/ Ø=10/8)  
N° YC110-23-024 (L=495MM/ Ø=10/8)  
N° YC110-23-025 (L=360MM/ Ø=10/10)

€ 19

SPECIAL PARTS  
YCF RACING



**JAUGÉ HUILE NOIRE/ BLEUE/ ROUGE/ VERTE/ ORANGE**  
OIL DIPSTICK BLACK/ BLUE/ RED/ GREEN/ ORANGE

N° JH-COLOR (LITE/ START/ PILOT/ BIGY 125/150 MX) € 19

SPECIAL PARTS  
YCF RACING



**BOUCHON VIDANGE AIMANTÉ**  
NOIR/ BLEU/ ROUGE/ VERT/ ORANGE  
MAGNETIC DRAIN PLUG  
BLACK/ BLUE/ RED/ GREEN/ ORANGE

01 N° BVE1-COLOR € 12

**HUBLOT À HUILE**  
OIL LEVEL SIGHT GLASS

02 N° D00C027 € 10

# ALLUMAGE IGNITION



## FAISCEAU ÉLECTRIQUE WIRING HARNESS

- 01 N° YC110-1501 (NON ÉTANCHANCHE/ NO WATERPROOF) € 15
- N° YC110-1501-12 START SE 88/125 (CONNECTEUR ÉTANCHE/ WATERPROOF CONNECTION) € 15
- N° YC110-1501-08 BIGY (DÉMARREUR ÉLECTRIQUE/ ÉLECTRIC START/ CONNECTEUR ÉTANCHE/ WATER-PROOF CONNECTION) € 19
- N° YC110-1501-09 BIGY (SANS DÉMARREUR/ WITHOUT ÉLECTRIC START CONNECTEUR ÉTANCHE/ WATERPROOF CONNECTION) € 19
- N° YC110-1501-11 (LITE/START/PILOT/SP) (SANS DÉMARREUR/ WITHOUT ÉLECTRIC START CONNECTEUR ÉTANCHE/ WATERPROOF CONNECTION) € 15

## BOÎTIER CDI CDI BOX

- 02 N° YC110-1503 € 15

## BOBINE HAUTE TENSION HIGH TENSION IGNITION COIL

- 03 N° YC110-1504 € 15

## BATTERIE BATTERY

- 04 N° YC110-1507-02 (88 & 125SE) € 39
- 04 N° YC110-1507-04 (190ZE) € 45



## CDI RACING CDI RACING

- N° YC110-1503-01 € 29



## ALLUMAGE YCF 50A YCF 50A IGNITION

- 01 N° YC50-0021 (CONTACTEUR CLÉ/ KEY SWITCH) € 12
- 02 N° YC50-1502 (RÉGULATEUR DE TENSION/ TENSION REGULATOR) € 15
- 03 N° YC50-1510 (RELAIS DÉMARREUR/ STARTER RELAY) € 15
- 04 N° YC50-1507-01 (BATTERIE POUR 50A/ BATTERY FOR 50A) € 35
- 05 N° YC50-1514 (CHARGEUR BATTERIE/ BATTERY CHARGER) € 35
- 06 N° YC110-0021-02 (CONTACTEUR CLÉ ÉTANCHE/ WATERPROOF KEY SWITCH) € 15
- 07 N° 82200-D083-000151 (DÉMARREUR 88/ 125SE) € 59
- 08 N° YC50-20-66 (DÉMARREUR 50A) € 59



## ALLUMAGE MAGNETO

- 01 N° RRG (ALLÉGÉ/ LIGHTWEIGHT) € 99
- 02 N° 31100/152FMH € 69
- 03 N° 31210/152FMH (PRISE ÉTANCHE) € 69
- 04 N° 82120-G011-30534 (START SE) € 35





### COUPE CIRCUIT

REMOTE SWITCH

- |  |      |
|--|------|
| 01 N° YC110-0105-01 (SWITCH ON/OFF)                  |      |
| 02 N° YC110-0105 (SWITCH)                            | € 15 |
| 03 N° YC110-0105-21(SWITCH-WATERPROOF)               | € 20 |
| 04 N° YC110-0105-05 (SWITCH + LEASH)                 | € 20 |
| 08 N° YC110-0139-03 (BOUTON DÉMARREUR/ START SWITCH) | € 15 |

### COMPTEUR D'HEURE & SUPPORT

HOURLY METER & SUPPORTING PLATE

- |  |      |
|--|------|
| 05 N° STANDCOMPT-H (SUPPORT/ SUPPORTING PLATE)                     | € 10 |
| 06 N° COMPT-H (COMPTEUR D'HEURE/ HOUR METER)                       | € 29 |
| 07 N° COMPT01-H (COMPTEUR D'HEURE VIBRATION/ HOUR METER VIBRATION) | € 39 |



FOR 50 ONLY

### COUPE CIRCUIT À DISTANCE VENDU AVEC 2 TÉLÉCOMMANDES

DISTANCE ENGINE CUT OFF  
SOLD WITH 2 REMOTES CONTROL

N° YC50-1518 € 79



### BOUGIE & ANTI PARASITE

SPARK PLUG & SPARK PLUG CAP

- |   |      |
|---|------|
| 01 N° 221D021 (4 SOUPAPES YX/ YX 4 STROKE)  | € 45 |
| 02 N° 34210/152FMH (CR7HS)                  | € 12 |
| 03 N° 34210/D8EA (D8EA 125 R START 2012-13) | € 9  |
| 04 N° YC110-1505 (CAP/ ANTI PARASITE)       | € 7  |



# DAYTONA® ANIMA® RACING PARTS/PIECES RACING



**CHAÎNE DE DISTRIBUTION RENFORCÉE D.I.D**  
D.I.D REINFORCED TIMING SPROCKET

N° 87577

€ 69



**PISTON FORGÉ POUR ANIMA®**  
FORGED PISTON FOR ANIMA®

N° 87173 (150cc)  
N° 88599 (190cc)

€ 89

€ 99



**KIT ARBRE À CAME RACING**  
RACING CAMSHAFT KIT

N° 87583

€ 299



**KIT 212cc**  
212cc KIT

N° 88011

€ 319



**KIT ALLUMAGE F-SM RÉGLABLE**  
MULTI CURVES ROTOR KIT

N° 87235

€ 269



**COUVRE FILTRE HUILE ANIMA® NOIR/ BLEU/ ROUGE/  
VERT/ ORANGE**

ANIMA® OIL FILTER COVER BLACK/ BLUE/ RED/ GREEN/  
ORANGE

N° OFCDAYT-COLOR

€ 25



**COUVRE CULASSE ANIMA® RACING**  
ANIMA® RACING CYLINDER HEAD COVER

N° 87994

€ 49



**PIPE ADMISSION ANIMA® 15°**  
INTAKE MANIFOLD ANIMA® 15°

N° YC110-2012-01

€ 45



**CHAÎNE DE DÉMARREUR RENFORCÉE DID**  
STARTER CHAIN DID

N° 89522

€ 49

# DAYTONA®



# DAYTONA® ANIMA® 2,0 150/ 190cc (4 VALVES) GENUINE PARTS/ PIÈCES D'ORIGINES



SEQ #	PART #	DESCRIPTION	QTY	(€) UNIT PRICE
1	86461	BOLT, CROSS RECESSED COUNTERSUNK M6x15	2	1,00
2	86464	BOLT, HEXAGON FLANGE M6x25	2	1,00
3	86472	BOLT, HEXAGON FLNAGE M6x32	1	1,00
4	86427	BOX, CDI, DESIGNATION FDX	1	119,00
4	88130	BOX, CDI FSM (12900 RPM MAX)	1	69,00
5	86426	COIL, IGNITION	1	19,00
6	86373	COVER, MAGNET	1	39,00
7	86431	FLYWHEEL MAGNET COMP FDX	1	69,00
7	88127	FLYWHEEL MAGNET COMP FSM	1	65,00
8	86452	NUT, MAGNET M12	1	2,00
9	86479	O-RING, Ø6,5xØ1,8	2	2,00
10	86430	STATOR ASSY, DESIGNATION FDX	1	69,00
10	88129	STATOR ASSEMBLY FSM	1	65,00
11	86428	WIRE HERNESS	1	39,00



SEQ #	PART #	DESCRIPTION	QTY	(€) UNIT PRICE
1	84678	BOLT, CROSS RECESSED COUNTERSUNK M6x30	1	2,00
2	84677	BOLT, CROSS RECESSED COUNTERSUNK M6x35	2	2,00
3	84676	GASKET, PUMP OIL	1	2,00
4	83747	PIN, DOWEL Ø8xØ6,3x12	2	2,00
5	86382	PUMP, OIL ASSY	1	49,00



SEQ #	PART #	DESCRIPTION	QTY	(€) UNIT PRICE
1	86446	BOLT, BANJO M10x22,5	2	3,00
2	86362	BOLT, HEXAGON FLANGE M6x105	1	2,00
3	86486	BOLT, HEXAGON FLANGE M6x15	2	3,00
4	86469	BOLT, HEXAGON FLANGE M6x22	2	2,00
5	86485	BOLT, HEXAGON FLANGE M6x28	2	2,00
6	86471	BOLT, HEXAGON FLANGE M6x30	2	2,00
7	86473	BOLT, HEXAGON FLANGE M6x50	2	2,00
8	86474	BOLT, HEXAGON FLANGE M6x55	1	2,00
9	83759	BOLT, HEXAGON FLANGE M6x60	1	2,00
10	86361	BOLT, HEXAGON FLANGE M6x90	1	2,00
11	86376	COVER, CLUTCH	1	119,00
12	86374	COVER, OIL FILTER	1	15,00
13	86377	COVER, SMALL CLUTCH	1	59,00
14	83489	FILTER, OIL	1	19,00
15	86437	GASKET, COVER CLUTCH	1	15,00
16	86476	GASKET, M10	4	2,00
17	86412	HOLDER, CABLE CLUTCH	1	9,00
18	86414	LEVER, CLUTCH COMP	1	35,00
19	86432	O-RING, Ø38,6x2,6	1	3,00
20	86435	O-RING, COVER SMALL CLUTCH	1	5,00
21	86441	OIL SEAL, Ø16xØ26x7	1	5,00
22	86442	OIL SEAL, Ø17xØ10x5	1	4,00
23	86406	OIL THROUGH COMP	2	25,00
24	83747	PIN, DOWEL Ø8xØ6,3x12	4	2,00
25	86386	RULER	1	5,00
26	86413	SPRING, LEVER CLUTCH	1	2,00
27	86375	SPRING, OIL FILTER	1	2,00
28	86475	WINDOW, OIL LEVEL	1	15,00



(€) UNIT PRICE

## ALLUMAGE GENERATOR

ANIMA® 2,0 150/ 190CC

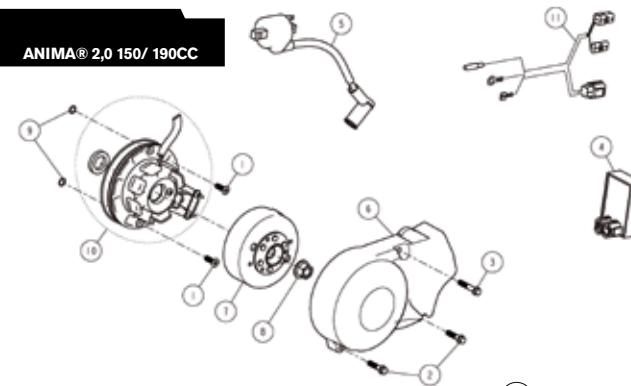

(€) UNIT PRICE

## POMPE À HUILE OIL PUMP

ANIMA® 2,0 150/ 190CC

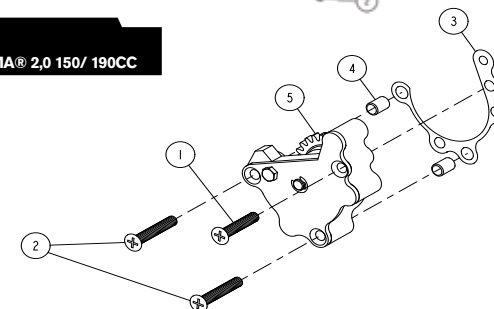

(€) UNIT PRICE

## CARTER EMBRAYAGE COVER CLUTCH

ANIMA® 2,0 150/ 190CC

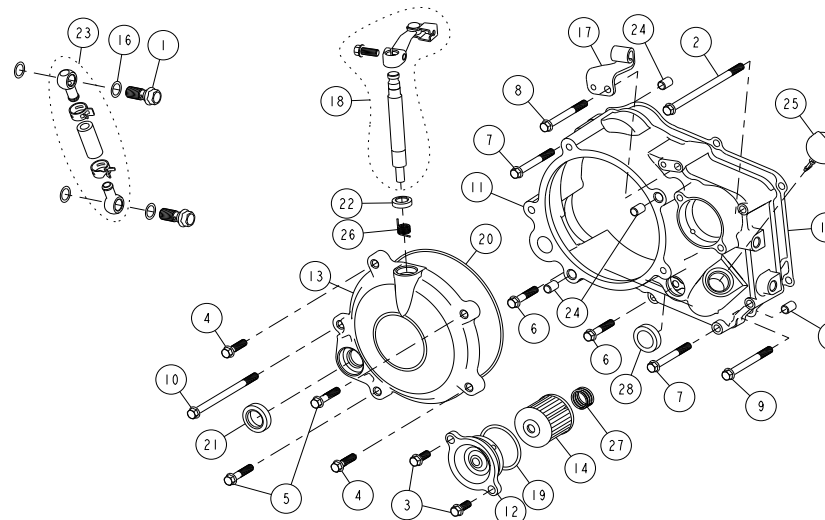

DAYTONA

SEQ #	PART #	DESCRIPTION	QTY	(€) UNIT PRICE
1	86453	CLIP, PIN PISTON	2	2,00
2	86381	CRANK SHAFT ASSY ANIMA 150	1	199,00
3	86620	CRANK SHAFT ASSY ANIMA 190	1	219,00
3	87760	CRANK SHAFT ASSY ANIMA 160	1	199,00
3	89144	CRANK SHAFT ASSY ANIMA 190-5 SPEEDS	1	229,00
4	86383	GEAR, OIL PUMP DRIVE	1	15,00
5	86415	GEAR, PRIMARY DRIVE	1	29,00
6	83768	NUT, SMALL M14	1	5,00
7	86443	OIL SEAL, Ø12xØ20x5t	1	6,00
8	86379	PIN, PISTON Ø14	1	5,00
9	86378	PISTON DT150	1	59,00
10	86621	PISTON DT190	1	65,00
11	86462	RETAINING RING, RTWN22	1	2,00
12	86380	RING SET, PISTON	1	30,00
13	86411	WASHER, SPRING	1	3,00

DAYTONA

PISTON & VILEBREQUIN  
PISTON & CRANK SHAFT

ANIMA® 2,0 150/ 190CC

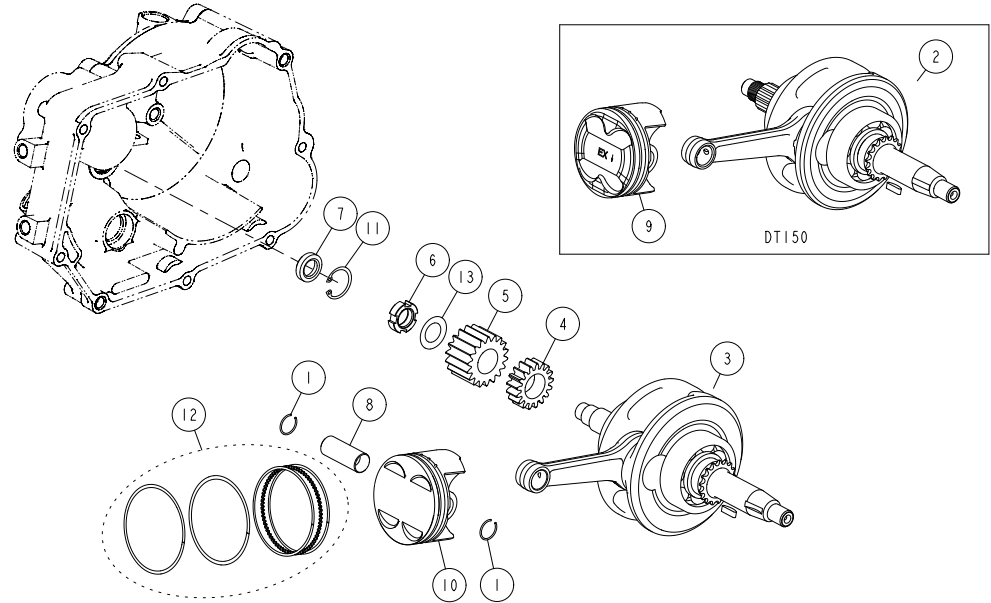

DAYTONA

SEQ #	PART #	DESCRIPTION	QTY	(€) UNIT PRICE
1	86474	BOLT, HEXAGON FLANGE M6x55	1	2,00
2	83761	BOLT, HEXAGON FLANGE M6x65	1	2,00
3	86360	BOLT, HEXAGON FLANGE M6x70	5	2,00
4	86459	BOLT, HEXAGON SOCKET M6x105	2	3,00
5	83755	BOLT, OIL DRAIN M12x15	1	3,00
6	86444	BOLT, STUD A	2	6,00
7	86445	BOLT, STUD B	2	6,00
8	86369	COVER, STRAINER OIL	1	5,00
9	86370	CRANK CASE, LH	1	129,00
9	89143	CRANK CASE, LH, 5 SPEEDS	1	149,00
10	86884	CRANK CASE, RH	1	119,00
10	88848	CRANK CASE, RH, 5 SPEEDS	1	119,00
11	86438	GASKET, CRANKCASE	1	9,00
12	86371	HOSE, BREATHER	1	12,00
13	86451	NUT FLANGE, M8	4	2,00
14	86433	O-RING, Ø30xØ3	1	2,00
15	83720	PIN, DOWELØ10xØ8,4x14	2	2,00
16	86385	SPRING, STRAINER	1	2,00
17	86387	STRAINER, OIL	1	29,00
18	86457	WASHER, GASKET M8	4	2,00
19	83754	WASHER, OIL DRAIN M12	1	5,00

DAYTONA

CARTER  
CRANKCASE

ANIMA® 2,0 150/ 190CC

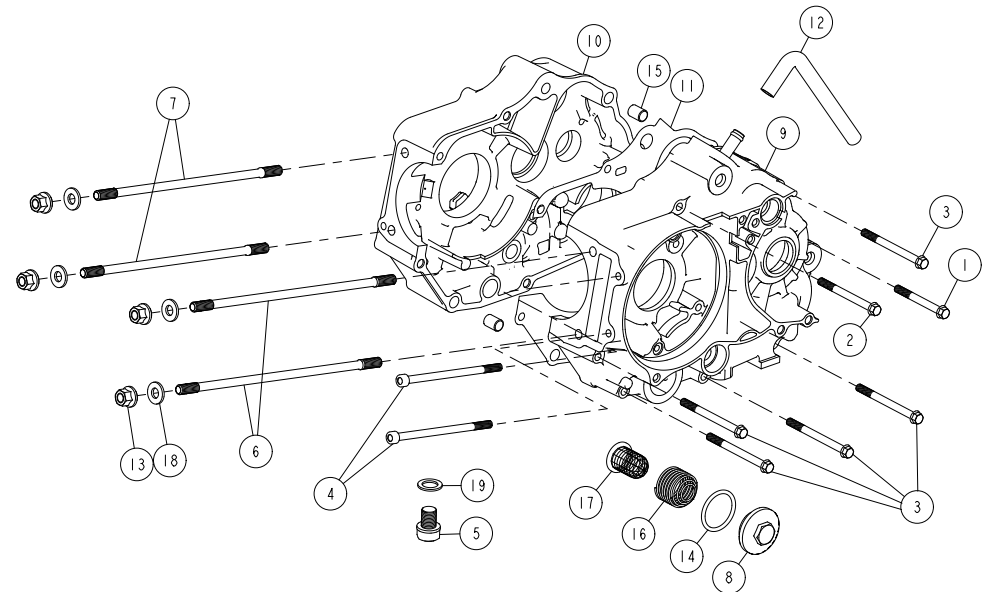

SEQ #	PART #	DESCRIPTION	QTY	(€) UNIT PRICE
1	86448	BOLT, HEXAGON FLANGE M10x16	1	3,00
2	85877	BOLT, HEXAGON FLANGE M6x12	1	1,00
3	86468	BOLT, HEXAGON FLANGE M6x18	6	1,00
4	86466	BOLT, HEXAGON FLANGE M6x25	1	1,00
5	86471	BOLT, HEXAGON FLANGE M6x30	1	2,00
6	83703	BOLT, STUD M6x32	2	2,00
7	86367	COVER, CYLINDER HEAD	1	45,00
8	86366	CYLINDER	1	249,00
9	86436	GASKET, BASE CYLINDER	1	15,00
10	86440	GASKET, HEAD CYLINDER	1	19,00
11	86476	GASKET, M10	1	2,00
12	86405	GASKET, MANIFOLD	1	2,00
13	86439	GASKET, TANSIONER CAM CHAIN	1	2,00
14	86368	HEAD, CYLINDER	1	249,00
15	86404	MANIFOLD, INTAKE	1	25,00
16	86479	O-RING	1	2,00
17	86434	O-RING, COVER HEAD	1	15,00
18	83720	PIN, DOWEL Ø10xØ8,4x14	4	2,00
19	83747	PIN, DOWEL Ø8xØ6,3x12	1	2,00
20	221D021	SPARK PLUG ER9EH	1	45,00
21	86396	TENSIONER, CAM CHAIN COMP	1	25,00
22	86456	WASHER, Ø6,3xØ12x1,5	1	2,00

### CULASSE ANIMA® HEAD CYLINDER

ANIMA® 2,0 150/ 190CC

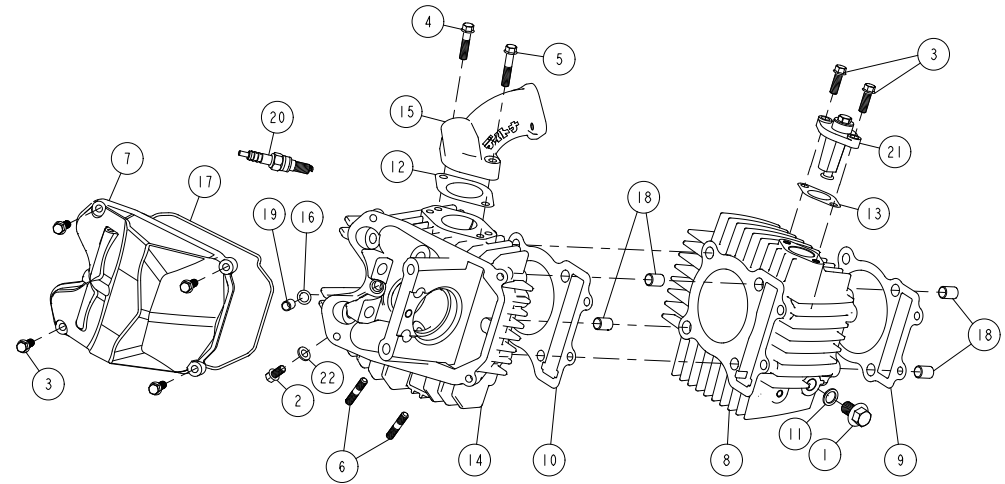

SEQ #	PART #	DESCRIPTION	QTY	(€) UNIT PRICE
1	86481	ARM, ROCKER ROLLER EXHAUST COMP	1	59,00
2	86393	ARM, ROCKER ROLLER INTAKE COMP	1	59,00
3	86460	BOLT, COUNTERSINK M6x15	1	1,00
4	86883	SCREW M6X16	2	2,00
5	86447	BOLT, TENSIONER	1	3,00
6	86878	CAMSHAFT 240Ø ROLLER DECOMP ASM	1	99,00
7	86391	CHAIN, CAMSHAFT DRIVE	1	35,00
8	86402	COTTER, VALVE	8	5,00
9	89681	SHAFT W/WEIGHT,DECOMP,V3	1	49,00
10	86395	GUDE , CHAIN CAMSHAFT	1	20,00
11	86389	PLATE, STOPPER CAM	1	5,00
12	86400	RETAINER, SPRING VALVE	4	5,00
13	86403	SEAL, VALVE STEM Ø4.5	4	6,00
14	86401	SEAT, SPRING VALVE	4	4,00
15	86392	SHAFT, ROCKER	2	5,00
16	87621	SPRING,RETURN DECOMP.	1	3,00
17	86624	SPRING, VALVE	4	16,00
18	86879	SPROCKET, CAMSHAFT DRIVEN	1	19,00
19	87620	PLATE,STOPPER DECOMP.	1	4,00
20	86394	TENSIONER, CAM CHAIN	1	20,00
21	86623	VALVE, EXHAUST Ø21	2	30,00
22	86397	VALVE, INTAKE Ø24.5	2	19,00

### DISTRIBUTION VALVE MECHANIS

ANIMA® 2,0 150/ 190CC

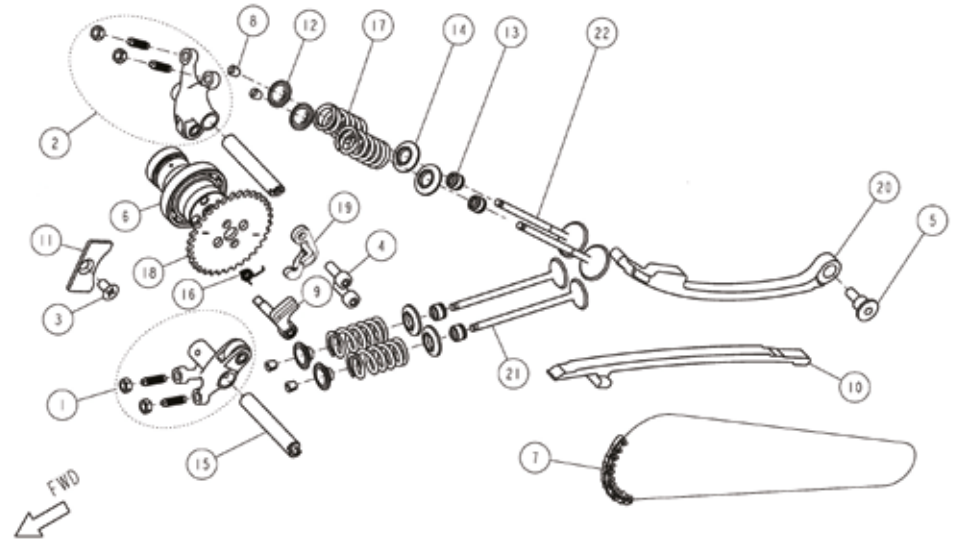

**DAYTONA**

SEQ #	PART #	DESCRIPTION	QTY	(€) UNIT PRICE
1	83786	BEARING, #6000	1	7,00
2	87619	CLUTCH COMP (FORGED GEAR)	1	199,00
3	86417	GEAR, STARTER DRIVEN 2 13T	1	25,00
4	83768	NUT, SMALL M14	1	5,00
5	83787	PIN, LIFTER CLUTCH	1	20,00
6	86410	WASHER, SPRING Ø24xØ14,2x1,2 1	1	1,00

**DAYTONA**

**EMBRAYAGE  
CLUTCH**

ANIMA® 2,0 150/ 190CC

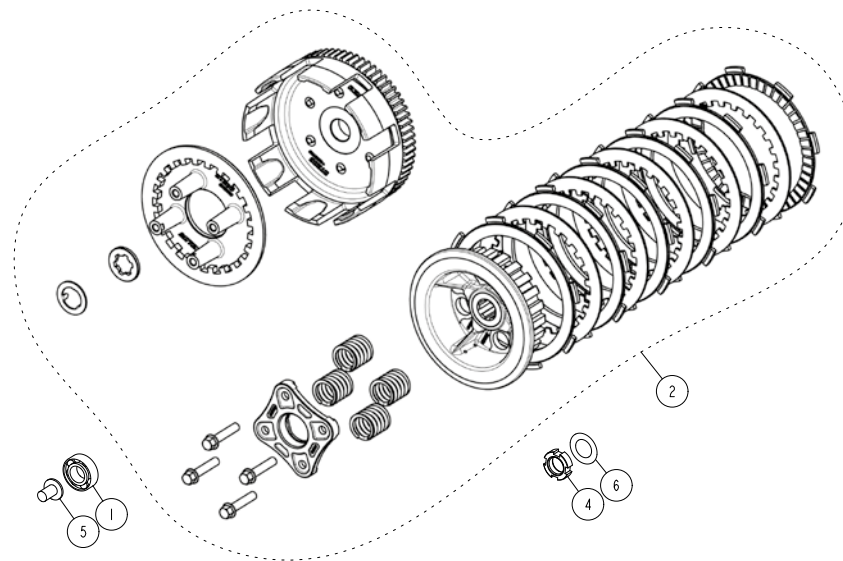

**DAYTONA**

SEQ #	PART #	DESCRIPTION	QTY	(€) UNIT PRICE
1	83788	BEARING #6001	1	12,00
2	83795	BEARING #6203	2	15,00
3	86454	BEARING NK152712	1	15,00
4	86464	BOLT, HEXAGON SOCKET M6x10	2	1,00
5	86418	GEAR IDLE, STARTER	1	20,00
6	86919	GEAR, COMP,4 SPEED	1	149,00
6	89682	GEAR, COMP 5 SPEED	1	149,00
7	83796	OIL SEAL, Ø29xØ17x5	1	3,00
8	86420	PLATE, FIXING SPROCKET DRIVE 1	1	2,00
9	86463	RETAINING RING Ø13,6	1	2,00
10	86419	SPROCKET, DRIVE 15T	1	15,00
11	86455	WASHER, Ø22xØ15x0,5	2	1,50

**DAYTONA**

**BOÎTE DE VITESSE  
GEARBOX**

ANIMA® 2,0 150/ 190CC

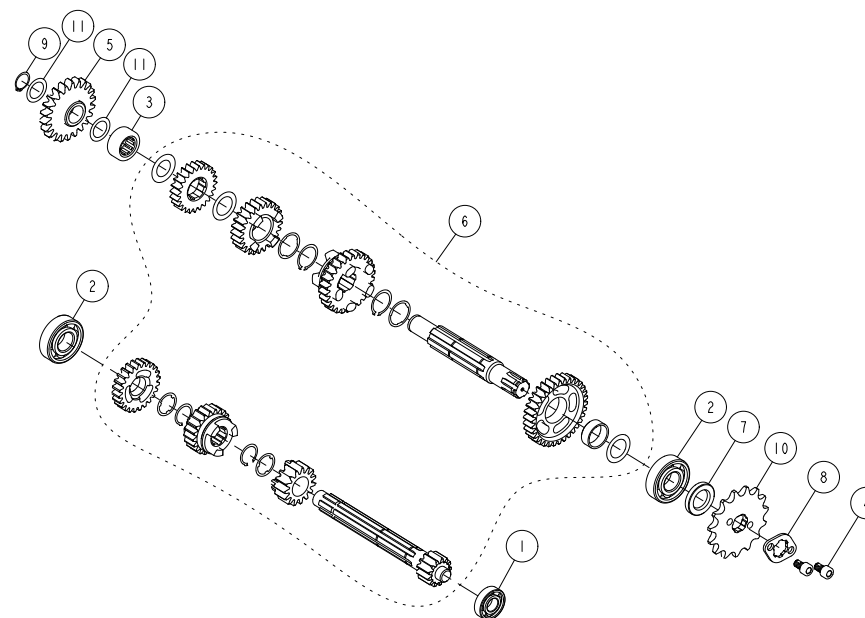



SEQ #	PART #	DESCRIPTION	QTY	(€) UNIT PRICE
1	86449	BOLT, HEXAGON SOCKET M6	1	2,00
2	85877	BOLT, HEXAGON SOCKET M6x15	1	1,00
3	83833	CONTACT, GEAR INDICATION	1	3,00
4	86421	DRUM, SHIFT N-1-2-3-4 COMP	1	55,00
4	88423	DRUM, SHIFT 5 SPEEDS	1	55,00
6	86422	LEVER, GEAR SHIFT COMP	1	20,00
6	88886	LEVER, GEAR SHIFT COMP 5 GEAR	1	20,00
7	86424	LOCATING PLATE UNIT	1	4,00
8	83837	OIL SEAL, Ø24xØ16x10	1	6,00
9	86480	PIN, LOCATING SHIFT LEVER	1	3,00
10	85876	PLATE, LOCATING SWITCH NEUTRAL	1	2,00
11	86423	SPRING, LOCATING PLATE	1	2,00



**BOÎTE/ FOURCHETTES  
GEARBOX MECHANISM**

ANIMA® 2,0 150/ 190CC

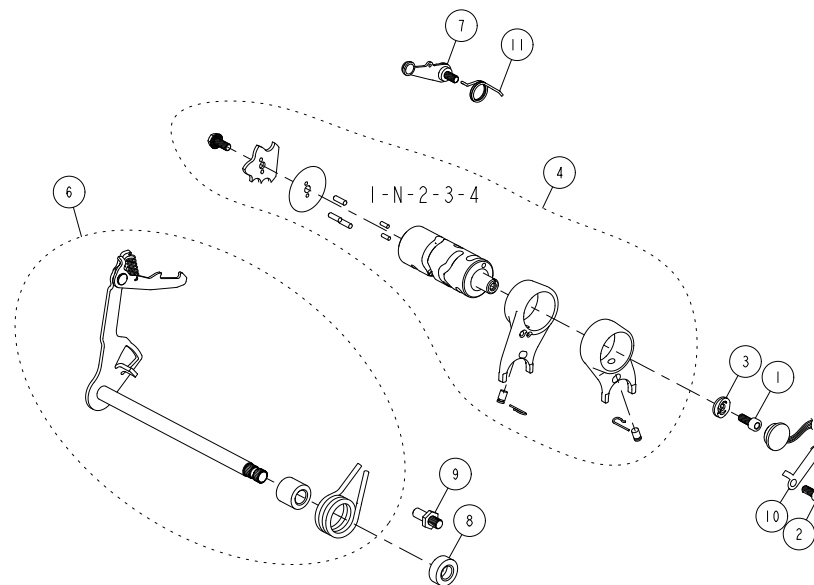

SEQ #	PART #	DESCRIPTION	QTY	(€) UNIT PRICE
1	86407	KICK STARTER ASM	1	75,00
1	88883	KICK ASSY 5 GEAR	1	69,00



**KICK  
KICK STARTER**

ANIMA® 2,0 150/ 190CC

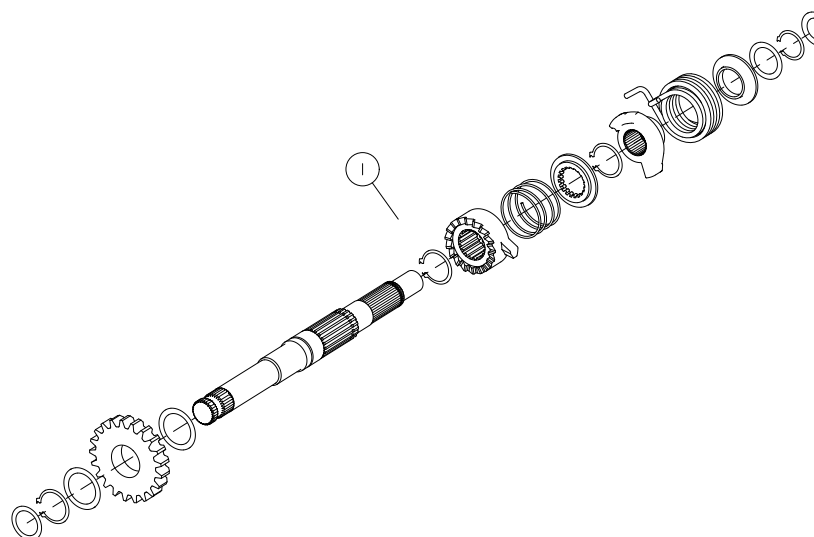

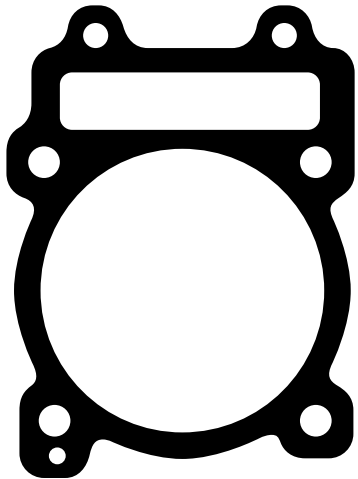

---

**ART DIRECTION**

ENCORE STUDIO

**GRAPHIC DESIGN**

F. ALAUX, T. JUMIN & Q. BRACHET

**INDUSTRIAL DESIGN**

FRANÇOIS ALAUX FOR YCF MOTORCYCLES

**THANKS TO**

#111

STEPHANE LE CORRE, CATHERINE HOSSARD & YCF CREW MEMBERS

TRISTAN LANE/ COLE WILLIAMS/ MIGUEL PEREZ/ MARLON SORBY/

MIKE ALESSI/ RICKY CARMICHAEL

**TRACK**

LANFRANCHI MX PARK/ SORBY ACADEMY



[WELCOMETOENCORE.COM](http://WELCOMETOENCORE.COM)

---

**PHOTOGRAPHY**

ACTION & STUDIO: JEFF KARDAS

PARTS: ANTOINE CADOT

**YCF FOUNDERS**

DIMITRI BERA & YANNICK COQUARD



**ENJOY  
YOUR  RIDE**

**YCF**

**TOUT LES MODÈLES PRÉSENTÉS SONT DES MOTOS  
AUX NORMES CE. VÉHICULE NON HOMOLOGUÉ  
ET INTERDIT SUR LA VOIE PUBLIQUE. USAGE  
RÉSERVÉ UNIQUEMENT SUR CIRCUIT FERMÉ  
ET PRIVÉ. TOUJOURS PORTER UN CASQUE, DES  
LUNETTES ET DES VÊTEMENTS DE PROTECTIONS.  
NE JAMAIS MONTER EN TANT QUE PASSAGER.**

ALL MODELS PRESENTED MEET EC STANDARDS.  
VEHICLES ARE NOT AUTHORIZED ON PUBLIC ROADWAYS.  
RESERVED FOR USE ON CLOSED AND PRIVATE TRACKS ONLY.  
ALWAYS WEAR HELMET, GOGGLE AND ADAPTED  
PROTECTIONS. NEVER RIDE WITH A PASSENGER.

**FOLLOW  
US!**

YouTube   

**CE**



**YCF SE RÉSERVE LE DROIT DE MODIFIER LES  
CARACTÉRISTIQUES ET LES PRIX DE SES PRODUITS.  
TOUTE REPRODUCTION MÊME PARTIELLE DE CE  
CATALOGUE DOIT FAIRE L'OBJET D'UN ACCORD  
PRÉALABLE AVEC YCF.**

YCF RESERVES THE RIGHT TO MODIFY THE SPECIFICATIONS  
OR THE PRICES OF ITS PRODUCTS. ANY REPRODUCTION  
IN WHOLE OR IN PART OF THIS CATALOGUE REQUIRES  
THE PRIOR AGREEMENT OF YCF.

**Ycf-Riding.com**